

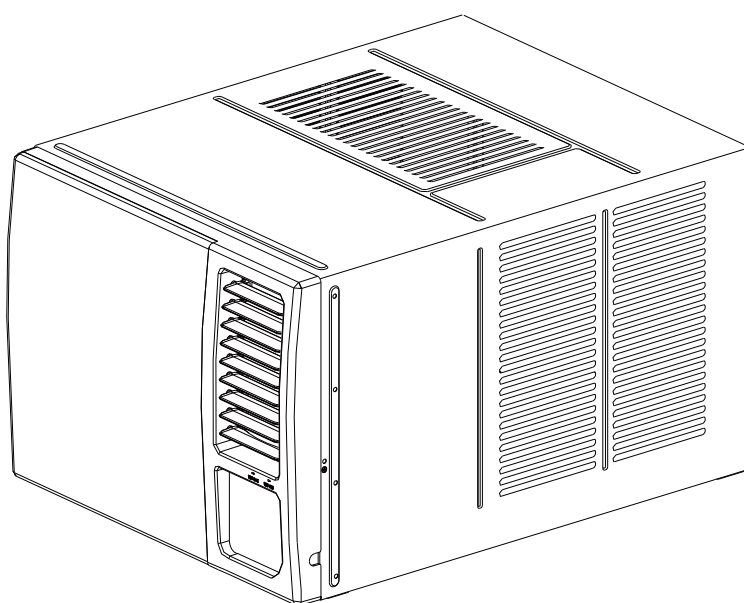

R32窗口式冷氣機 (淨冷)

使用說明書及安裝說明書



型號:

RC-V7AC

RC-V9AC

RC-V12AC

RC-V18AC

重要提示:



本設備使用 R32 輕度易燃製冷劑。
在安裝或操作之前，請仔細閱讀本手冊。請妥善保管本手冊以備將來參考。
適用的型號、技術資料見機身銘牌。

安全須知

操作和安裝前請閱讀安全須知

由於忽視說明而導致錯誤安裝可能會產生嚴重的損壞或傷害。



1. 安裝（空間）

- 必須由授權經銷商或經過專業培訓的技術人員進行安裝。
- 製冷劑管道應符合國家氣體法規。
- 機械連接應便於維護。
- 在需要機械通風的情況下，通風口應保持暢通無阻。
- 處理使用過的產品時，應根據國家規定妥善處理。

2. 維修

- 任何操作或拆解製冷劑回路的人員都必須持有行業認可的評估機構頒發的有效證書，該證書授權其根據行業認可的評估規範安全處理製冷劑。

3. 維護和修理需要其他技術人員的協助，應在有能力使用易燃製冷劑的人員監督下進行。

4. 除廠家推薦的方法外，請勿使用任何其他方法加速除霜過程或進行清潔。

5. 電器應存放在沒有持續工作的點火源的房間內（例如：明火、工作的燃氣器具或電加熱器）。

6. **請勿**讓異物（油、水等）進入配管。此外，在保管配管時，請通過夾緊、膠帶等將開口密封好。

7. **請勿**刺穿或燃燒。

8. 請注意，製冷劑可能沒有氣味。

9. 所有影響安全措施的工作程式只能由合資格人員進行。

10. 電器應存放在通風良好的區域，房間大小應與具體操作面積相符。

11. 存放電器時應防止發生機械損壞。





12. 電器使用輕度易燃製冷劑R32，並經測試符合IEC 60335-2-40。電器沒有最小房間面積要求。

13. 安裝高度不得低於0.75米。

裝置運輸、標記和儲存

1. 含有易燃製冷劑的設備的運輸
遵守運輸法規
2. 使用標誌標記設備
遵守當地法規
3. 使用易燃製冷劑的設備的處置
遵守國家法規
4. 設備/電器的存放
設備的儲存應按照製造商的說明進行。
5. 已包裝（未售出）設備的存放
儲存包裝保護裝置的結構應確保包裝內的設備發生機械損壞時不會導致製冷劑洩漏。
允許存放在一起的最大設備件數根據當地法規確定。

本機顯示符號的說明

	警告	此符號表示本電器使用輕度易燃製冷劑。如果製冷劑洩漏並暴露於外部火源，則有著火的風險。
	小心	此符號表示應仔細閱讀使用說明書。
	小心	此符號表示維修人員應參考安裝說明書處理此設備。
	小心	此符號表示使用說明書或安裝說明書提供相關資訊。

目錄

警告	03
裝置部件識別	09
操作面板	10
保養和維護	12
排水	12
安裝說明	13
故障排除	16
規格	17

環境保護

2018年12月31日起，被棄置受管制電器處置管制、進出口管制及堆填區棄置禁令正式實施。任何人儲存、處理、再加工或循環再造被棄置受管制電器，均須取得廢物處置牌照；輸入及輸出被棄置受管制電器均須領有許可證。堆填區及其他指定廢物處置設施（例如廢物轉運站）則不會再接收和處置被棄置受管制電器。

警告

請在操作和安裝前閱讀

由於忽視說明而導致錯誤安裝可能會產生嚴重的損壞或傷害。潛在損壞或傷害的嚴重性分為警告或小心。



警告

此符號表示可能造成人員受傷或死亡。



小心

此符號表示可能造成財產損失或嚴重後果。



警告

本電器可供身體、感官或精神能力有缺陷或缺乏經驗和知識的人員（包括兒童）使用，前提是有負責人員提供有關電器使用的監督或指導。應監督兒童以避免其玩耍本電器。



產品使用警告

- 本設備使用 R32 輕度易燃製冷劑。
- 如果出現異常情況（如燒焦味），請立即關閉電器並斷開電源。請致電您的經銷商獲取有關避免觸電、火災或人身傷害的指導。
- **請勿**將手指、杆或其他物體插入進風口或出風口，否則可能會導致人身傷害，因為風扇可能在高速旋轉。
- **請勿**在本機附近使用髮膠、油漆或塗料等易燃噴霧劑，否則可能會導致火災或燃燒。
- **請勿**在可燃氣體附近或周圍運行冷氣機。散發的氣體可能會聚集在設備周圍並導致爆炸。
- **請勿**在浴室或洗衣房等潮濕的房間內使用冷氣機。過多接觸水會導致電氣元件短路。
- **請勿**將身體長時間直接暴露在冷空氣中。
- **請勿**讓兒童玩耍冷氣機。兒童在設備周圍時必須始終受到監督。
- 如果冷氣機與燃燒器或其他加熱設備一起使用，請徹底通風，以免缺氧。
- 在某些功能環境中，如廚房、伺服器機房等，強烈建議使用專門設計的冷氣機。
- 如果發出奇怪的聲音、氣味或煙霧，請拔下設備插頭或斷開電源。
- 為進一步優化設備性能，請在操作期間保持門窗關閉。
- 開箱安裝時要注意，鋒利的邊緣可能會造成傷害。

清潔和維護警告

- 清潔前關閉設備並斷開電源，否則可能會導致觸電。
- **請勿**使用過多的水清潔冷氣機。
- **請勿**使用可燃清潔劑清潔冷氣機，否則可能會引起火災或變形。



小心

- 如果長時間不使用，請關閉冷氣機並斷開電源。
- 在暴風雨期間關閉並拔掉設備插頭。
- 確保冷凝水可以從設備中暢通無阻地排出。
- **請勿**用濕手操作冷氣機，否則可能會導致觸電。
- **請勿**將設備用於預期用途以外的任何其他目的。
- **請勿**攀爬或在室外機頂部放置物體。
- **請勿**讓冷氣機長時間在門窗打開或者在濕度非常高的情況下運行。

電氣警告

- 僅使用指定的電源線。如果電源線損壞，必須由製造商、其服務代理商或類似的合資格人員更換，以避免發生危險。
- 保持電源插頭清潔。清除積聚在插頭上或插頭周圍的任何灰塵或污垢。髒插頭會導致火災或觸電。
- **請勿**拉扯電源線以拔下設備插頭。請握住插頭並將其從插座中拔出。直接拉扯會損壞電源線，從而導致火災或觸電。
- **請勿**修改電源線的長度或使用延長線為設備供電。
- **請勿**與其他電器共用電源插座。電源供應不當或不足會導致火災或觸電。始終安裝斷路器和專用電源電路。
- 如果插座鬆動或損壞，**請勿**使用。
- **請勿**在電源線上放置重物，並確保電源線沒有被壓扁，否則有火災或觸電的危險。
- 如果水進入設備，請在電源插座處關閉設備並關閉斷路器。拔下電源插頭或斷開設備電源，並聯繫合資格的維修技術人員。
- 產品安裝時必須正確接地，否則可能會發生觸電。
- 對於所有電氣工作，請遵循所有當地和國家接線標準、法規以及設備頂部面板上的電氣連接圖。
- 如果將電源連接到固定接線，應使用所有極間至少有3毫米間隙且漏電流可能超過10mA的全極斷開裝置，剩餘電流裝置（RCD）的額定剩餘工作電流不超過30mA，並且必須按照接線規則將斷開裝置包含在固定接線中。
- 本機通過電源線接地，確保裝置正確接地。壁式插座（空氣開關）應有可靠的地線。
- 設備應配備獨立電路，斷路器/保險絲額定值應與電源線和壁式插座的額定值相同。電源線導體根據顏色區分，如機器頂部的接線圖所示。

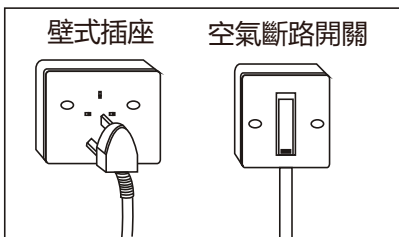

注意保險絲規格

冷氣機的電路板（PCB）設計有保險絲以提供過流保護。電路板上印有保險絲的規格，如220V。

產品安裝警告

1. 安裝必須由授權經銷商或專業人員進行。有缺陷的安裝會導致漏水、觸電或火災。
2. 安裝必須按照安裝說明進行。安裝不當會導致漏水、觸電或火災。
3. 聯繫授權服務技術人員修理或維護本設備。本電器應按照國家接線規定進行安裝。
4. 只能使用附帶的附件、零件和指定的零件進行安裝。使用非標準部件會導致漏水、觸電、火災，並可能導致設備故障。
5. 將設備安裝在能夠支撐設備重量的穩固位置。如果選擇的位置不能支撐設備重量，或者安裝不當，設備可能會掉落並導致嚴重的人身傷害和損壞。
6. 按照本手冊中的說明安裝排水管道。排水不當可能會對您的房屋和財產造成損壞。
7. 對於帶有輔助電加熱器的裝置，請勿將裝置安裝在距離任何可燃材料1米（3英尺）的範圍內。
8. **請勿**將設備安裝在可能暴露於可燃氣體洩漏的位置。如果可燃氣體積聚在本機周圍，可能會引起火災。
9. 在所有工作完成之前**請勿**打開電源。
10. 移動或重新安置冷氣機時，請諮詢有經驗的維修技術人員進行裝置的斷開和重新安裝。
11. 關於如何將電器安裝到支架上，請閱讀“安裝說明”部分的詳細資訊。

使用R32製冷劑的警告

- 除廠家推薦的方法外，請勿使用任何其他方法加速除霜過程或進行清潔。
- 電器應存放在沒有持續工作的點火源（例如：明火、工作的燃氣器具）的房間內，並且電器附近不得有火源（例如：工作的電加熱器）。
- **請勿**刺穿或燃燒。
- 請注意，製冷劑可能沒有氣味。
- 應遵守國家氣體法規。
- 保持通風口暢通無阻。
- 妥善存放電器以防止發生機械損壞。
- 電器應存放在通風良好的區域，房間大小應與具體操作面積相符。
- 任何操作或拆解製冷劑回路的人員都必須持有行業認可的評估機構頒發的有效證書，該證書授權其根據行業認可的評估規範安全處理製冷劑。
- 維護和修理需要其他技術人員的協助，應在有能力使用易燃製冷劑的人員監督下進行。
- 請仔細按照說明操作、安裝、清理、維修冷氣機，以免造成任何損壞或危險。冷氣機使用可燃製冷劑R32。維修或處置冷氣機時，應妥善回收製冷劑（R32），不得直接排放到空氣中。
- 冷氣機周圍不得有任何明火或開關等可能產生火花/電弧的裝置，以免引起易燃製冷劑著火。請仔細按照說明存放或維護冷氣機，以免發生機械損壞。
- 冷氣機使用易燃製冷劑。請仔細按照說明進行操作，以免發生任何危險。



警告：低燃速材料
(IEC 60335-2-40:2018適用於
R32型號)

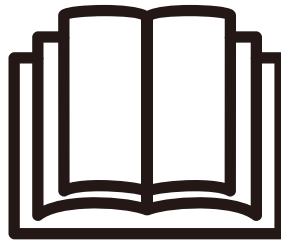

重要說明：安裝或操作冷氣機之前請仔細閱讀本說明書。

本機顯示符號說明（僅適用於採用R32製冷劑的機組）：

	警告	此符號表示本電器使用輕度易燃製冷劑。如果製冷劑洩漏並暴露於外部火源，則有著火的風險。		小心	此符號表示維修人員應參考安裝說明書處理此設備。
	小心	此符號表示應仔細閱讀使用說明書。		小心	此符號表示使用說明書或安裝說明書提供相關資訊。

1. 含有易燃製冷劑的設備的運輸

遵守運輸法規

2. 使用標誌標記設備

遵守當地法規

3. 使用易燃製冷劑的設備的處置

遵守國家法規

4. 設備/電器的存放

設備的儲存應按照製造商的說明進行。

5. 已包裝（未售出）設備的存放

儲存包裝保護裝置的結構應確保包裝內的設備發生機械損壞時不會導致製冷劑洩漏。允許存放在一起的最大設備件數根據當地法規確定。

6. 維修資訊

1) 現場檢查

在開始對含有易燃製冷劑的系統進行操作之前，必須進行安全檢查以確保將著火風險降至最低。對於製冷系統的維修，在對系統進行操作之前應遵守以下預防措施。

2) 工作程序

工作應在受控程式下進行，以最大程度地減少工作期間出現易燃氣體或蒸汽的風險。

3) 一般工作區

所有維修人員和在當地工作的其他人員都應瞭解所進行工作的性質。應避免在密閉空間內工作。工作區周圍的區域應分隔開。通過控制易燃材料，確保該區域內的狀況安全。

4) 檢查是否有製冷劑

在工作之前和工作期間，應使用適當的製冷劑檢測器檢查該區域，以確保技術人員瞭解潛在的易燃環境。確保所使用的洩漏檢測設備適用於易燃製冷劑，即無火花、充分密封或本質安全。

5) 配備滅火器

如果對製冷設備或任何相關部件進行任何熱加工，應準備好合適的滅火設備。在充注區附近放置一個乾粉或二氧化碳滅火器。

6) 無火源

任何人在可能暴露於含有或曾經含有易燃製冷劑的任何管道工程的製冷系統上執行操作時，不得以可能導致火災或爆炸風險的方式使用任何點火源。所有可能的火源，包括吸煙，都應遠離安裝、維修、拆卸和處置場所，在此期間，易燃製冷劑可能會釋放到周圍空間。在開始工作之前，應檢查設備周圍的區域，以確保沒有易燃危險或著火風險。應張貼禁止吸煙標誌。

7) 通風區域

在進入系統或進行任何高溫作業之前，確保該區域處於開放狀態或充分通風。在工作過程中應保持一定程度的通風。通風應安全地分散釋放的製冷劑，最好將其從外部排放到大氣中。

8) 製冷設備檢查

更換的電氣元件應適合用途並符合正確的規格。應始終遵守製造商的維護和服務指南。如有疑問，請諮詢製造商的技術部門尋求幫助。對使用可燃製冷劑的裝置應進行以下檢查：充注量與含製冷劑部件安裝房間的大小一致；

通風設備和出風口運行正常，沒有堵塞；

如果使用間接製冷回路，應檢查二次回路是否存在製冷劑；設備上的標記仍然清晰可見。難以辨認的標記和標誌應予以糾正；製冷管道或部件的安裝位置應避免暴露於任何可能腐蝕含製冷劑部件的物質，除非這些部件由具有固有抗腐蝕能力的材料製成，或者有適當的保護以防止腐蝕。

9) 檢查電氣設備

電氣元件的維修和維護應包括初始安全檢查和元件檢查程式。如果存在可能危及安全的故障，則在妥善處理之前，不得將電源連接到電路。如果故障不能立即糾正，但需要繼續運行，則應採用適當的臨時解決方案。應將情況報告給設備所有者，以便通知所有各方。初始安全檢查應包括：

電容器放電：應以安全的方式進行，以避免產生火花的可能性；
充注、回收或清洗系統時，沒有帶電的電氣元件和線路暴露在外；
接地連接具有連續性。

7. 密封元件的修理

- 1)在修理密封元件過程中，在拆除密封蓋等之前，應將所有電源與正在工作的設備斷開。如果在維修過程中必須
- 2)為設備供電，則最關鍵的點應有永久運行的洩漏檢測形式，以警告潛在的危險情況。

應特別注意以下事項，以確保在對電氣元件進行操作時，不會改變外殼從而影響防護等級，包括電纜損壞、連接數量過多、端子不符合原始規格、密封件損壞、壓蓋安裝不正確等。

確保設備安裝牢固。

確保密封件或密封材料沒有退化，以確保其能夠起到防止可燃氣體進入的作用。更換零件應符合製造商的規格。

注意：使用矽密封膠可能會抑制某些類型的洩漏檢測設備的有效性。本安組件在處理之前不必隔離。

8. 本安組件維修

請勿在電路上施加任何永久性電感或電容負載，除非確保不會超過所用設備的允許電壓和電流。本安元件是唯一可以在有易燃氣體的情況下工作的類型。測試設備應處於正確的額定值。只能使用製造商指定的部件更換元件。其他部件可能會因洩漏而導致大氣中的製冷劑著火。

9. 佈線

檢查佈線是否會受到磨損、腐蝕、過度壓力、振動、銳邊或任何其他不利環境影響。檢查還應考慮壓縮機或風扇等造成的老化或持續振動的影響。

10. 可燃製冷劑檢測

在任何情況下都不得使用潛在的點火源尋找或檢測製冷劑洩漏。

不得使用鹵素燈（或任何其他使用明火的探測器）。

11. 洩漏檢測方法

以下洩漏檢測方法適用於含易燃製冷劑的系統。應使用電子檢漏儀檢測易燃製冷劑，但靈敏度可能不夠，或者可能需要重新校準。（檢測設備應在無製冷劑的區域進行校準。）確保檢測器不是潛在的點火源並且適合所使用的製冷劑。洩漏檢測設備應設置為製冷劑LFL的百分比，並應根據所使用的製冷劑進行校準，並確認適當的氣體百分比（最大25%）。檢漏液適用於大多數製冷劑，但應避免使用含氯的清潔劑，因為氯可能與製冷劑發生反應並腐蝕銅管。如果懷疑有洩漏，應移走/熄滅所有明火。如果發現需要鈎焊的製冷劑洩漏，則應從系統中回收所有製冷劑，或將系統中遠離洩漏的部分隔離（通過截止閥）。然後，在鈎焊過程之前和過程中，應通過系統吹掃無氧氮氣（OFN）。

12. 清除和排空

當進入製冷劑回路進行維修或出於任何其他目的時，應使用常規程式。然而，重要的是遵循最佳做法，因為需要考慮易燃性。不得通過鈎焊打開製冷系統。應遵循以下程式：

清除製冷劑；

用惰性氣體吹掃電路；

排空；

再次用惰性氣體吹掃；

通過切割或鈎焊打開電路。

應將充注的製冷劑回收到適當的回收鋼瓶中。系統應使用OFN進行沖洗以確保設備安全。這一過程可能需要重複幾次。此任務不得使用壓縮空氣或氧氣。

沖洗時用OFN打破系統中的真空並繼續填充直到達到工作壓力，然後排放到大氣中，最後抽真空來實現。應重複此過程，直到系統內沒有製冷劑為止。

當使用最終OFN充注時，系統應排放至大氣壓力以進行工作。如果要在管道上進行鈎焊操作，此操作至關重要。確保真空泵的出口不靠近任何點火源，並且有通風。

13. 充注程式

除常規充注程式外，還應遵循以下要求。確保在使用充注設備時不會發生不同製冷劑的污染。軟管或管線應盡可能短，以儘量減少其中的製冷劑含量。

鋼瓶應保持直立。

在向系統充注製冷劑之前，確保製冷系統已接地。

充注完成時給系統貼上標籤（如果還未貼）。

應特別注意不要將製冷系統裝得過滿。

在給系統充注之前，應使用OFN對其進行壓力測試。系統應在充注完成後試運轉之前進行洩漏測試。離開現場前應進行後續洩漏測試。

14. 停止運行

在執行此程式之前，技術人員必須完全熟悉設備及其所有細節。建議的良好做法是安全回收所有製冷劑。在執行任務之前，應採集油和製冷劑樣本，以防在重新使用回收的製冷劑之前需要進行分析。在任務開始之前，必須連接電源。

- a) 熟悉設備及其操作。
- b) 電氣隔離系統。
- c) 在嘗試該程式之前，請確保：
必要時可使用機械搬運設備來搬運製冷劑鋼瓶；
所有個人防護設備都可用並正確使用；
回收過程始終由合格人員監督；
回收設備和鋼瓶符合相應的標準。
- d) 如果可能，抽空製冷系統。
- e) 如果無法實現真空，則製作一個歧管，以便可以從系統的各個部分排出製冷劑。
- f) 在回收之前確保鋼瓶位於秤上。
- g) 啟動回收機並按照製造商的說明進行操作。
- h) 請勿過度充注鋼瓶（液體充注體積不超過80%）。
- i) 不得超過鋼瓶的最大工作壓力，即使是暫時的。
- j) 當鋼瓶正確加注並完成該過程後，確保立即將鋼瓶和設備移出現場，並關閉設備上的所有隔離閥。
- k) 回收的製冷劑除非經過清潔和檢查，否則不得充注到另一個製冷系統中。

15. 標籤

設備應貼上標籤，說明其已停用並排空製冷劑。標籤應注明日期並簽名。確保設備上有標籤，說明設備含有易燃製冷劑。

16. 回收

從系統中移除製冷劑時，無論是為了維修還是停用，建議的良好做法安全是移除所有製冷劑。將製冷劑轉移到鋼瓶中時，確保僅使用合適的製冷劑回收鋼瓶。確保可以使用正確數量的鋼瓶來容納系統總充氣量。使用的所有鋼瓶都指定用於回收的製冷劑並有相應標記（即用於回收製冷劑的特殊鋼瓶）。鋼瓶應配有狀態良好的壓力釋放閥和相關截止閥。空的回收鋼瓶應排空，如果可能，回收之前應冷卻。回收設備應處於良好的工作狀態，並附有一套關於適用於可燃製冷劑回收的設備的說明。此外，應備有一套校準過並處於良好工作狀態的秤。軟管應配備無洩漏斷開接頭且狀況良好。在使用回收機之前，檢查是否處於良好的工作狀態，是否得到了適當的維護，並且所有相關的電氣元件都已密封，以防止在製冷劑洩漏時著火。如有疑問，請諮詢製造商。

回收的製冷劑應使用適當的回收鋼瓶退回給製冷劑供應商，並安排相關的廢物轉移單。請勿在回收裝置中混合製冷劑，尤其是在鋼瓶中。如果要清除壓縮機或壓縮機油，請確保將排空到可接受的水準，以確保潤滑劑中不會殘留易燃製冷劑。排空過程應在將壓縮機返還給供應商之前進行。只能對壓縮機本體採用電加熱來加速這一過程。從系統中排油時，應安全進行。

當使用易燃製冷劑時，電器應存放在通風良好的地方。

工作溫度

當冷氣機在以下溫度範圍之外使用時，某些安全保護功能可能會啟動並導致設備無法使用。

製冷運行	室外溫度	18°C-43°C (64°F-109°F)
	室內溫度	17°C-32°C (62°F-90°F)

要進一步優化設備的性能，請執行以下操作：

- 保持門窗關閉。
- 冷氣機的製冷效能必須適合房間大小，以便高效地運行。
- 請勿堵塞空氣入口或出口。
- 定期檢查和清潔空氣篩檢程式。
- 如果設備電源不是指定額定值 $\pm 10\%$ ，則設備可能無法運行且保險絲可能熔斷。
- 夜間冷氣機發出的噪音會比白天大。這是因為夜間環境噪音相對較低。如果您覺得噪音太大，請將恆溫器切換到較低的數字。

裝置部件識別

注意：不同型號有不同的前面板和機櫃。本說明書中的插圖僅用於說明。機體的實際外形可能略有不同，請以實際外形為準。參考下圖：

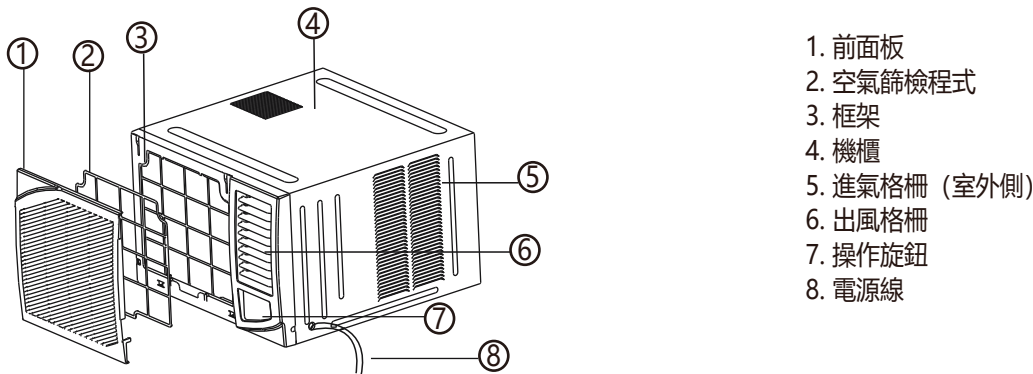

配件

密封件
(用於排水
接頭)



1個

排水接頭



1個

排水盤



1個

橡膠塞



1個

螺釘



2個

通風口控制

通風口控制位於控制旋鈕上方。不同型號的操作方法和外形可能有所不同（見下圖）。為獲得最大製冷效率，請關閉通風口，從而使內部空氣循環。打开通風口排出不新鮮的空氣。

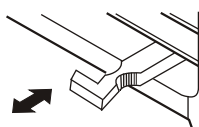

RC-V12AC
RC-V18AC

關閉 通風口 打開

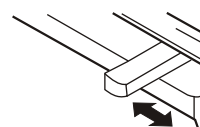

RC-V7AC
RC-V9AC

關閉 打開

注意：並非所有裝置都有通風口控制。

操作面板

注意：以下圖形用於說明，請以實際外形為準。

控制器	檔位	說明
溫度設定旋鈕	1-12	當旋鈕順時針轉動時，錶盤上的數字越大（冷卻設置越高）表示溫度越低。
功能選擇旋鈕	OFF	冷氣機已關閉。
	LOW FAN	風扇僅以低速運行，沒有冷卻效果。
	MED FAN	風扇僅以中速運行，沒有冷卻效果。
	HIGH FAN	風扇僅高速運轉，沒有冷卻效果。
	LOW COOL	風扇低轉速，冷卻效果最小。
	MED COOL	風扇中等轉速，冷卻效果中等。
	HIGH COOL	風扇高轉速，冷卻效果最大。

注意：

POWER指示燈(如有)：

該指示燈在冷氣機開啟時保持亮起，在功能選擇按鈕設置為“OFF”位置時熄滅。

壓縮機指示燈(如有)：

該指示燈顯示壓縮機的狀態。壓縮機啟動時亮，壓縮機停止時熄滅。

如何操作

您所購買的冷氣機的溫度設定按鈕和功能選擇旋鈕可能如下所示，以實際形狀為準：

溫度設定按鈕

順時針轉動溫度設定按鈕 控制以降低溫度。
 逆時針轉動溫度設定按鈕 控制以增加溫度。
 當設備在製冷模式下運行時，溫度設定按鈕用於設置所需的室溫。
 當室溫高於溫度設定按鈕設置時，壓縮機會自動開啟以提供涼爽的效果。
 當室溫低於溫度設定按鈕設置時，壓縮機自動關閉以停止冷卻。

重要提示：在通過功能選擇按鈕或溫度設定按鈕關閉製冷操作後重新啟動製冷操作時，請確保至少等待3分鐘。否則，保險絲可能會因設備過載而熔斷。

溫度設定按鈕

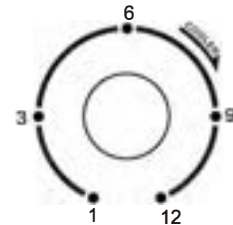

功能選擇按鈕

要設置所需的操作模式，請將功能選擇按鈕旋转到適當的位置。（參見上一頁的說明）

例如：

要在炎熱的夏天獲得最大的製冷效果，請選擇功能選擇按鈕上的HIGH COOL位置。當功能選擇按鈕設置在“HIGH FAN”位置時，僅啟動風扇，使空氣在沒有冷卻效果的情況下循環。

功能選擇按鈕

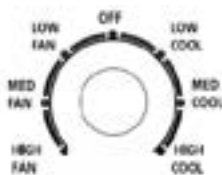

RC-V7AC
 RC-V9AC
 RC-V12AC



RC-V18AC

警告：

如果功能選擇按鈕已關閉或從冷卻模式設置為風扇模式，請等待至少 3 分鐘，然後再重置為冷卻模式。將功能選擇按鈕從 LOW COOL 轉到 HIGH COOL 時，請保持慢速並記住不要過於頻繁地更改操作模式。

例如：

要在炎熱的夏天獲得最大的製冷效果，請選擇功能選擇按鈕上的 HIGH COOL 位置。當功能選擇按鈕設置在 HIGH FAN 位置時，僅啟動風扇，使空氣在沒有冷卻作用的情況下循環。

重要提示：

如果功能選擇按鈕已關閉或從冷卻模式設置為風扇模式，請等待至少 3 分鐘，然後再重置為冷卻模式。將功能選擇按鈕從 LOW COOL 轉到 HIGH COOL 時，請保持慢速並記住不要過於頻繁地更改操作模式。

操作面板蓋

對於帶操作面板蓋的裝置

1. 抓住操作蓋的左側並將其拉開。
 2. 關閉操作蓋並再次按下直至其卡入鎖定位置。
- 請勿按壓或擺動打開的操作蓋。

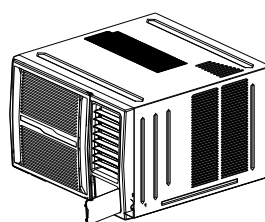

風向控制

● 水平氣流調節

對於帶自動擺風開關的機型（自動）

當自動擺風開關撥到“開”位置時，水平氣流百葉窗左右擺動，交替掃過冷空氣，獲得舒適的冷卻效果。當自動擺風開關轉到“關”位置時，百葉窗可以停在任何位置（見圖A）。

對於帶手動控制杆的機型（手動）

要調整水平氣流方向，用手輕輕向左或向右移動控制杆，直到獲得所需的水平氣流方向（見圖B）。

● 垂直氣流調節（手動）

裝置運行時，用手調節百葉，改變垂直氣流方向。可以握住百葉並移動到所需位置，從而設置氣流的垂直角度（見圖C）。

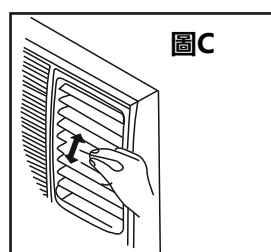
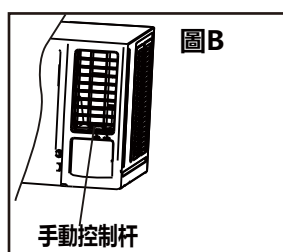
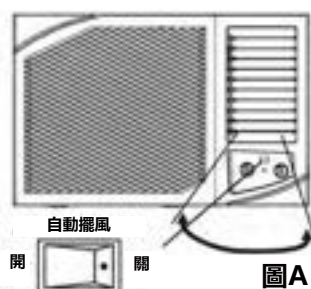

保養和維護

⚠️ 清潔或維護之前

在清潔或維護之前，請務必關閉冷氣機系統並斷開其電源。

清潔設備

⚠️ 重要

機櫃和前面板可用無油布擦拭或用布蘸溫水與溫和洗碗液溶液清洗。徹底沖洗並擦乾。

- 請勿在冷氣機附近使用油漆或髮膠等易燃噴霧劑。
- 請勿使用苯、酒精、汽油、酸、油漆稀釋劑、拋光粉或其他溶劑清潔本機，否則可能會損壞設備。
- 請勿使用超過50 °C (122 °F) 的水清潔前面板，否則會導致面板變形或變色。
- 控制器內部或周圍過多的水可能會損壞冷氣機。在擦拭乾淨之前，一定要擰乾布上多餘的水。

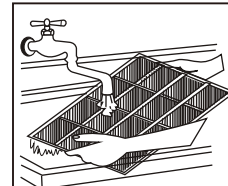
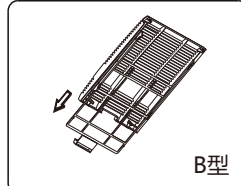
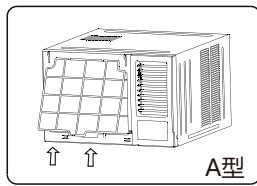
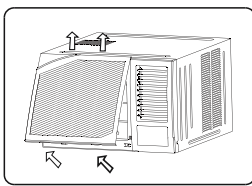

清潔空氣濾網

空氣濾網堵塞會降低設備的製冷效率並增加運行噪音。確保在頻繁操作期間每兩周（或根據需要）清潔一次濾網。

1. 握住前面板下方的插槽，向外提起，取下前面板。
2. 捏住空氣濾網下方的把手，使空氣濾網呈拱形，從卡槽中從下往上取出（A型）。抓住濾網的把手，然後將其向下滑動以取下濾網（B型）。
3. 用溫肥皂水清潔濾網。水溫應低於40 °C (104 °F) 以防止濾網變形。
4. 如果濾網帶有小型空氣清新濾網，請使用手持真空吸塵器清潔此濾網。
5. 用清水沖洗空氣濾網，然後甩掉多餘的水。
6. 在陰涼乾燥處晾乾，避免陽光直射。

如果濾網有一個小的空氣清新濾網（可選），可安裝在四個位置中的任何一個。用手持真空吸塵器清潔濾網。

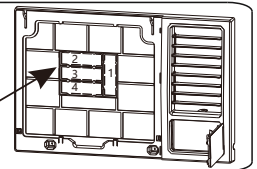

⚠️ 小心

切勿在沒有空氣濾網的情況下運行冷氣機，因為灰塵/污垢顆粒會導致設備故障。

冬季儲存

如果要在冬季存放冷氣機，請按照安裝說明小心地將其從窗戶上取下。用塑膠蓋住或將其放回原包裝箱中。

排水

冷凝水的處理方法如下：

底部排水（僅適用於設計有底部排水孔的裝置。）

- 取下機櫃底部的橡膠塞（如果有）
- 從附件中取出排水盤和螺釘。
- 用螺釘將排水盤固定在機櫃底部。
- 將延長排水軟管（當地購買）連接到排水盤的出口。

注意：底部排水會輕微影響製冷性能，但可以減少因噴灑冷凝水而產生的噪音。對於泵加熱，必須選擇底部排水。

後排水

- 將密封件安裝到排水接頭上（附件提供）。
- 將排水接頭插入後排水孔，將其旋轉90°以貼合。
- 將延長排水軟管（根據安裝長度要求在當地購買）連接到排水接頭。
- 確保用橡膠塞堵住底部排水孔。

注意：後排水會輕微影響製冷性能，但可以減少因噴灑冷凝水而產生的噪音。

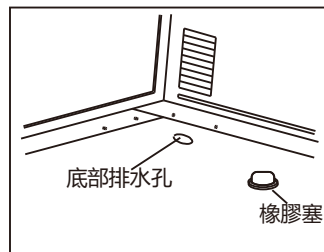

底部排水

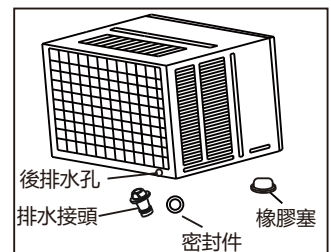

後排水

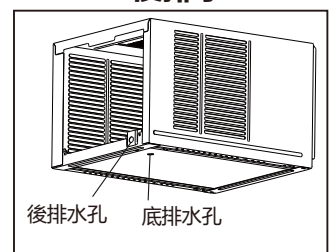
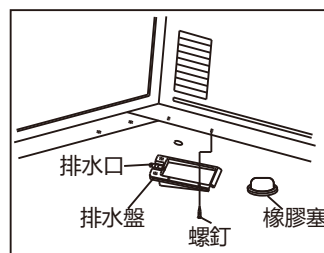

不排水

不排水

如果選擇製冷時不排水，則應用橡膠塞堵住機組底部和後排水孔。冷凝水噴到冷凝器，提高製冷性能。

注意：選擇不排水時，冷氣機將具有完美的製冷效率，但可能會因噴出冷凝水而產生較大的噪音。如果您對噪音敏感，請不要選擇該選項。

產品注意事項

- 額定製冷性能是在不排水狀態下測試的。
- 確保在使用橡膠塞和接頭時周圍不會漏水。如果發現洩漏，請密封。

安裝說明

安裝前

小心：安裝前，請從紙箱內取出所有包裝。

第1步：選擇最佳位置

- 為避免振動和噪音，請確保設備安裝牢固。
- 將設備安裝在陽光不會直接照射到的地方。如果設備受到陽光直射，請搭建遮陽篷為機櫃遮陰。
- 櫃體背面50釐米內不得有柵欄、牆壁等障礙物，以免冷凝器散熱。外界空氣限制會大大降低冷氣機的製冷和制熱效率。
- 將設備向外稍微傾斜向下安裝，以免冷凝水洩漏到室內（約3~4°）。
- 將設備底部安裝在高於地面75~150釐米的位置。
- 電源線必須連接到獨立的電路上。黃/綠線必須接地。

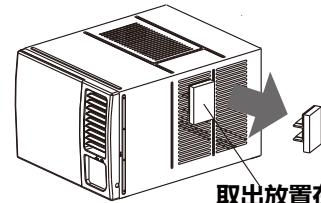

取出放置在側百葉中的外掛程式

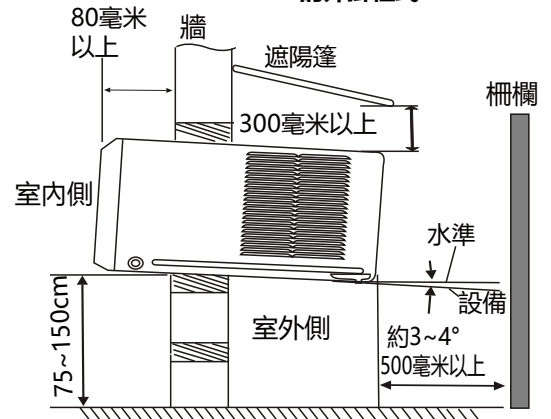

小心

機櫃的所有側百葉都必須暴露在結構的外部。

選項A

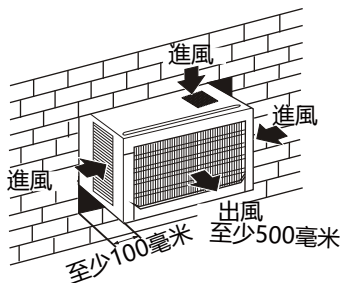

選項B

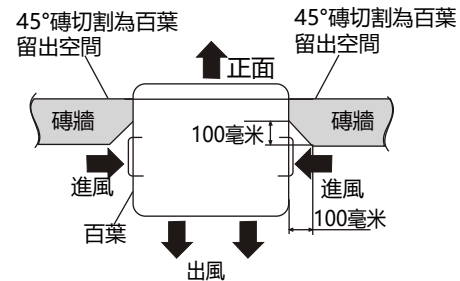

第2步：取下前面板和空氣濾網

- 從包裝中取出冷氣機。
- 握住前面板下方的插槽，向外提起，取下前面板（見圖1）。
- 抓住濾網末端的拉環，將其向上提起，然後朝自己拉，將濾網拉出（見圖2）。

第3步：取下機架

- 拆下機架底部的兩顆螺釘（見圖3）。
 - 斷開耦合器插頭並確保不會干擾溫度感測器電纜。握住機架的左下側，將其向上提起以解鎖下側，然後朝自己將其取下（見圖4）。
- 注意：對於某些設備，前面板和機架不安裝在設備背面，不需要第2步和第3步。

第4步：取下機櫃



圖1



圖2

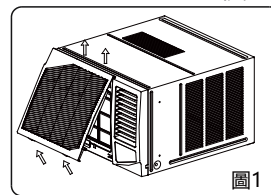

圖3

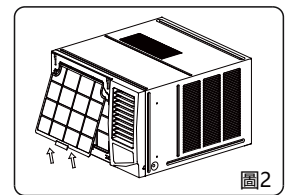

圖4

1. 取下固定主機殼固定支架的一顆螺釘，然後取下主機殼固定支架。取下機櫃背面的兩顆螺釘，如圖5B所示。
2. 抓住主機殼上的把手，小心地將冷氣機滑出機櫃。（見圖6）

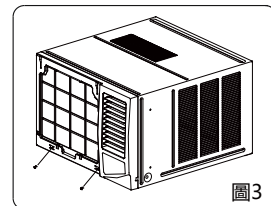

第5步：安裝機櫃

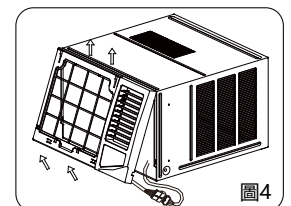
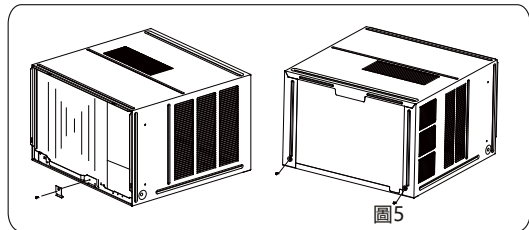
注意：裝置可由下方的實心機架支撐，或由實心頭頂支架上的吊架支撐（需單獨購買，請聯繫經銷商）。

1. 需要排水時，將放水塞安裝在底盤上。
2. 準備牆上的孔，使機櫃底部得到很好的支撐，頂部間隙最小，進風百葉的間隙如上一頁所示（圖選項A和B）。應密封從外部到腔體的孔。機櫃應向後傾斜約5~7毫米，以便將操作過程中形成的水排出。
3. 將機櫃安裝到牆上並固定。確保泡沫密封沒有損壞。對內部和外部周圍的縫隙加薄片、密封或填充，以提供良好的外觀和抵禦天氣、昆蟲和齧齒動物的保護。（見圖7）

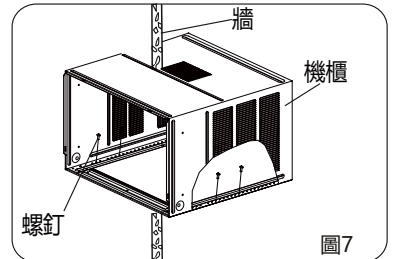
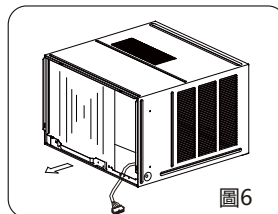

第6步：將設備安裝到機櫃中

1. 將設備滑入機櫃，直到牢牢靠在機櫃後部。需要注意確保機櫃上的泡沫密封條保持原位（見圖8）。
2. 將冷氣機連接到電源並將多餘的電線放置在冷氣機底座下方。
3. 將主機殼固定支架卡入機櫃底部導軌，並用提供的螺釘固定在底座上。

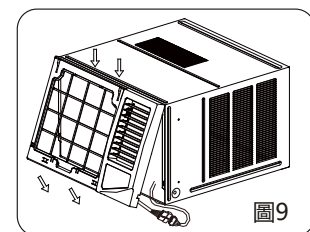
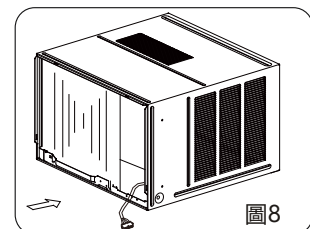
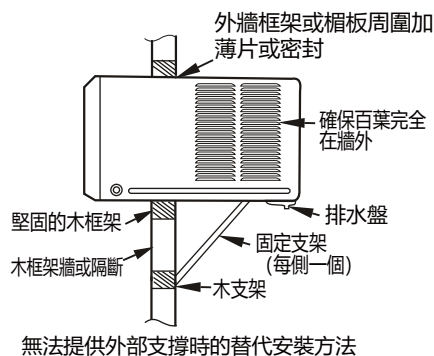
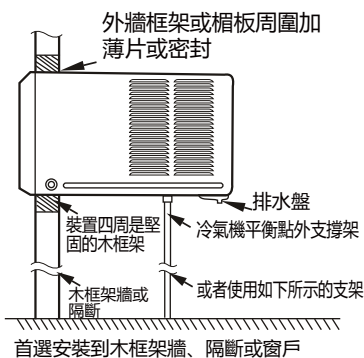

第7步：安裝框架

1. 鉤住機架的上邊緣，然後連接耦合器插頭並確保不會干擾溫度感測器電纜（見圖9）。
2. 按壓機架的兩側和下邊緣，用兩顆螺釘固定在機架底部。（見圖10）

第8步：安裝空氣濾網和前面板

1. 將空氣濾網從上向下插入機架的插槽中。（見圖2）
2. 將前面板掛在機架的搭扣上，然後將前面板按入機架的插槽，直到聽到啞聲（見圖11）。
3. 開啟設備。檢查裝置運行情況，並在安裝後檢查振動。
4. 將排水盤安裝到機櫃上，並在需要時將排水軟管連接到合適的位置。

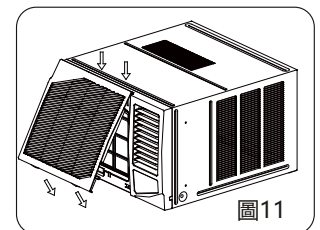
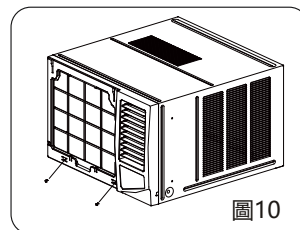

注意：對於電源線在左側的裝置，請執行以下步驟：

1. 將電源線向左側拉直（見圖a和b）。
2. 用紮線帶將電源線上的PVC保護套纏繞在孔位（見圖c）。
3. 將電源線綁在機架上（見圖d和e）（僅適用於機身尺寸為600 * 380 * 560毫米的裝置）。
4. 按照上述第6步和第7步安裝機架和前面板。

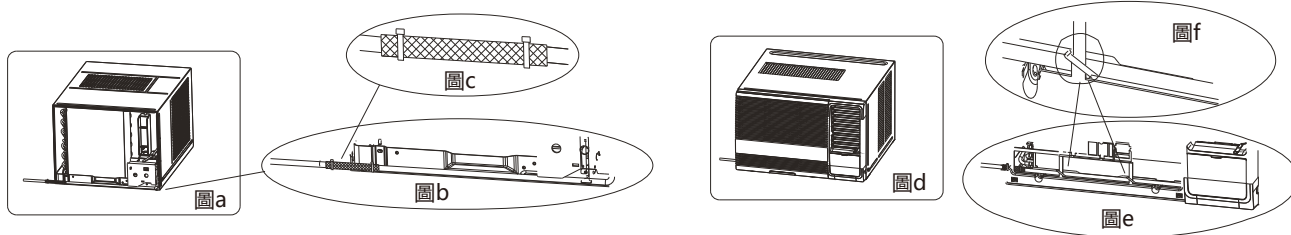

故障排除

安全須知

如果出現以下任何一種情況，請立即關閉設備！

- 電源線損壞或異常發熱
- 有燒焦的氣味
- 設備發出響亮或異常的聲音
- 電源保險絲熔斷或斷路器頻繁跳閘
- 水或其他物體落入或落出本機

請勿試圖自己解決這些問題！立即聯繫信興電器服務中心有限公司！

常見問題

以下問題不是故障，在大多數情況下不需要維修。

問題	可能原因	處理方法
冷氣機不能開啟	● 冷氣機插頭沒有插好。	● 確保冷氣機的插頭已經插好，並已打開。
	● 保險絲斷了或者斷路器跳閘。	● 檢查房屋的保險絲或斷路器，更換保險絲或復位斷路器。
	● 電路故障	● 如果出現電路故障，請關掉冷氣機，拔下插頭與電源線。電力恢復后，重新連接（插好）電源線，打開電源，等3分鐘重新啟動冷氣機，避免壓縮機過載而跳閘
冷氣機製冷不夠	● 氣流受阻。	● 確保冷氣機沒被窗簾、百葉窗或家具等阻擋。
	● 濾塵網變髒。	● 至少每週清潔一次濾網。請參考操作指引的部分。
	● 房間內溫度過高	● 如果冷氣機剛開，需要一定時間才能降低房間溫度。
	● 冷空氣外溢。	● 檢查門窗是否開啟
	● 蒸發器結冰。	● 把冷氣機的通風口設定為關閉為止。 ● 參考下面的“冷氣機結冰”。
冷氣機結冰	● 冰塊阻礙，冷氣機不能使房間降溫。	● 把風速設定到“中風”或“高風”檔，直到冰塊融化。
製冷模式時有噪音	● 空氣流動的聲音。	● 這個是正常的，如果聲音太大，請將選擇器轉到較低的風速。
	● 風扇碰到除水系統的聲音。	● 濕度高時這是正常現象。關閉房門，窗和存儲器。
	● 窗戶振動-安裝不良。	● 請參閱安裝說明或與安裝程序一起檢查。

規格

設備尺寸：

型號 (But/h)	機身尺寸(闊x高x深)(mm)
RC-V7AC RC-V9AC	450.6x350x675
RC-V12AC	600x380x560
RC-V18AC	660x428x680

選擇正確的電纜尺寸

所需的電源線、信號線、保險絲和開關的尺寸由設備的最大電流決定。最大電流顯示在設備側面板的銘牌上。請參閱此銘牌以選擇正確的電纜、保險絲或開關。

注意：針對不同的定制需求，面板深度可能略有不同，因此“深”僅供參考。

● 特別聲明

1. 以上資料已經過核對；如有任何印刷錯誤或內容方面的誤解，本公司將保留解釋權。
2. 本產品若有技術方面的改進，新版的操作說明中將會加入有關資料，恕不另行通知。產品外觀及顏色以冷氣機實物為準。
3. 本公司可應要求通過電子郵件發送電子版的用戶指南，請致電信興電工工程有限公司熱線電話2861 2767。

● 售後服務

保修期為購買日起計一年。如產品損毀屬正常使用下發生者，本公司可提供免費維修服務。請出示正式收據及蓋有銷售點/換購中心印章的保修證，以享用免費維修服務。如有查詢，請致電信興電器服務中心有限公司熱線電話2406 5666。

如發生以下任何情況，請立即關閉電源並聯絡信興電器服務中心有限公司。

- 斷路器經常跳掣或保險絲常被燒斷。
- 水或異物意外進入冷氣機內。
- 冷氣機操作時發出異常聲音。

Rasonic 樂信牌



SHUN HING GROUP
信興集團
SINCE 1953

信興電工工程有限公司

SHUN HING ELECTRIC WORKS & ENGINEERING CO., LTD

辦公室: 香港九龍尖沙咀東部麼地道 67 號半島中心 9 樓

OFFICE: 9/F, PENINSULA CENTRE, 67 MODY ROAD, TSIMSHATSUI EAST,
KOWLOON, HONG KONG

電話 TEL: (852) 2861 2767

傳真 FAX: (852) 2865 6706

網址 WEBSITE: www.rasonic.hk

電郵 EMAIL: shew@shunhinggroup.com

保養及維修 MAINTENANCE AND REPAIR SERVICE

信興電器服務中心有限公司

SHUN HING ELECTRIC SERVICE CENTRE LTD.

辦公室: 香港新界葵涌勝耀街2號信興中心11樓

OFFICE: 11TH FLOOR, SHUN HING CENTRE, 2 SHING YIU STREET, KWAI CHUNG, NEW
TERRITORIES, HONG KONG

電話 TEL: (852) 2406 5666

傳真 FAX: (852) 2408 0316

網址 WEBSITE: www.shesc.com

消耗品/附件銷售熱線 CONSUMABLES/ ACCESSORIES SALES HOTLINE

電話 TEL: (852) 2406 5666

客戶服務中心 CUSTOMER SERVICE CENTRES

香港新界葵涌勝耀街2號信興中心1樓

1ST FLOOR, SHUN HING CENTRE, 2 SHING YIU STREET, KWAI CHUNG, NEW
TERRITORIES, HONG KONG

電話 TEL: (852) 2406 5439

傳真 FAX: (852) 2408 1389

澳門慕拉士大馬路193-199號南嶺工業大廈5樓I座

AVENIDA DE VENCESLAU DE MORAIS, NO. 193-199, 5 ANDAR-I, EDF. INDUSTRIAL
NAM LENG, MACAU

電話 TEL: (853) 2836 2928

傳真 FAX: (853) 2833 6405

有關最新之客戶服務中心資訊, 請參閱信興服務中心網址: www.shesc.com或致電維修服務熱線查詢。

For the latest information of customer service centres, please visit www.shesc.com or call us at our hotline.



R32 WINDOW-TYPE AIR CONDITIONER(COOLING ONLY)

Operation Manual & Installation Manual

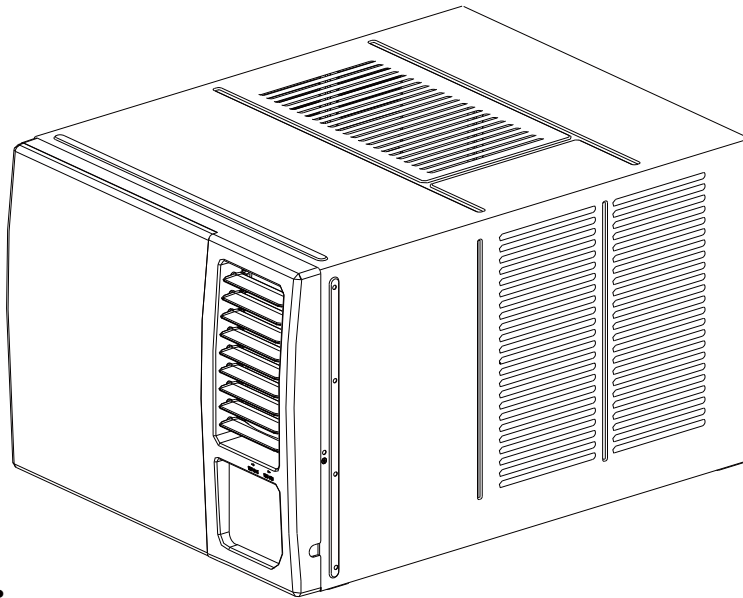

Model:
RC-V7AC
RC-V9AC
RC-V12AC
RC-V18AC

IMPORTANT NOTE:



This appliance is using R32 mildly flammable refrigerant. Read this manual carefully before installing or operating. Make sure to save this manual for future reference.

Please check the applicable models, technical data from the nameplate pasted on the unit.

WARNING

Read WARNING Before Operation and Installation

Incorrect installation due to ignore of instructions can cause serious damage or injury.

WARNING

1. Installation (Space)
 - Installation must be performed by an authorized dealer or professionally trained technician.
 - Where refrigerant pipes shall be compliance with national gas regulations.
 - That mechanical connections shall be accessible for maintenance purposes.
 - In cases that require mechanical ventilation, ventilation openings shall be kept clear of obstruction.
 - When disposing of the product is used, be based on national regulations, properly processed.
 2. Servicing
 - Any person who is involved with working on or breaking into a refrigerant circuit should hold a current valid certificate from an industry-accredited assessment authority, which authorises their competence to handle refrigerants safely in accordance with an industry recognised assessment specification.
 3. Maintenance and repair requires the assistance of other skilled personnel shall be carried out under the supervision of the person competent in the use of flammable refrigerants.
 4. **Do not** use means to accelerate the defrosting process or to clean, other than those recommended by the manufacturer.
 5. The appliance shall be stored in a room without continuously operating ignition sources (for example: open flames, an operating gas appliance or an operating electric heater)
 6. Be more careful that foreign matter (oil, water, etc) does not enter the piping. Also, when storing the piping, securely seal the opening by pinching, taping, etc.
 7. **Do not** pierce or burn.
 8. Be aware that refrigerants may not contain an odour.
 9. All working procedure that affects safety means shall only be carried by competent persons.
 10. Appliance shall be stored in a well-ventilated area where the room size corresponds to the room area as specified for operation.
 11. The appliance shall be stored so as to prevent mechanical damage from occurring.
 12. The appliance is using mildly flammable refrigerant R32 and tested to comply with IEC 60335-2-40. There is no minimum room area requirement for the appliance.
 13. The installation height shall not be lower than 0.75m.
-

Transportation, marking and storage for units

1. Transport of equipment containing flammable refrigerants
Compliance with the transport regulations
2. Marking of equipment using signs
Compliance with local regulations
3. Disposal of equipment using flammable refrigerants
Compliance with national regulations
4. Storage of equipment/appliances
The storage of equipment should be in accordance with the manufacturer's instructions.
5. Storage of packed (unsold) equipment
Storage package protection should be constructed such that mechanical damage to the equipment inside the package will not cause a leak of the refrigerant charge.
The maximum number of pieces of equipment permitted to be stored together will be determined by local regulations.

Explanation of symbols displayed on the unit





	WARNING	This symbol shows that this appliance used a mildly flammable refrigerant. If the refrigerant is leaked and exposed to an external ignition source, there is a risk of fire.
	CAUTION	This symbol shows that the operation manual should be read carefully.
	CAUTION	This symbol shows that a service personnel should be handling this equipment with reference to the installation manual.
	CAUTION	This symbol shows that information is available such as the operating manual or installation manual.

Table of Contents

Safety Precautions	03
Unit Parts Identification	09
Operation Panel	10
Care and Maintenance.....	12
Water Drainage	12
Installation Instructions	14
Troubleshooting.....	17
Specifications	18

Environment

Effective from 31 December 2018, the disposal licensing control, import and export permit control and landfill disposal ban in respect of abandoned regulated electrical equipment (REE) have commenced. Any person who is engaged in the storage, treatment, reprocessing or recycling of abandoned REE must obtain a waste disposal licence; a permit is required for the import and export of abandoned REE; and abandoned REE is no longer be accepted for disposal at the landfills and other designated waste disposal facilities (e.g. refuse transfer stations).

Safety Precautions

Read Safety Precautions Before Operation and Installation

Incorrect installation due to ignoring instructions can cause serious damage or injury.

The seriousness of potential damage or injuries is classified as either a **WARNING** or **CAUTION**.



WARNING

This symbol indicates the possibility of personnel injury or loss of life.



CAUTION

This symbol indicates the possibility of property damage or serious consequences.



WARNING

This appliance is not intended for use by persons (including children) with reduced physical, sensory or mental capabilities, or lack of experience and knowledge, unless they have been given supervision or instruction concerning use of the appliance by a person responsible for their safety. Children should be supervised to ensure that they do not play with the appliance.



WARNINGS FOR PRODUCT USE

- This appliance is using R32 mildly flammable refrigerant.
- If an abnormal situation arises (like a burning smell), immediately turn off the unit and disconnect the power. Call your dealer for instructions to avoid electric shock, fire or injury.
- **Do not** insert fingers, rods or other objects into the air inlet or outlet. This may cause injury, since the fan may be rotating at high speeds.
- **Do not** use flammable sprays such as hair spray, lacquer or paint near the unit. This may cause fire or combustion.
- **Do not** operate the air conditioner in places near or around combustible gases. Emitted gas may collect around the unit and cause explosion.
- **Do not** operate your air conditioner in a wet room such as a bathroom or laundry room. Too much exposure to water can cause electrical components to short circuit.
- **Do not** expose your body directly to cool air for a prolonged period of time.
- **Do not** allow children to play with the air conditioner. Children must be supervised around the unit at all times.
- If the air conditioner is used together with burners or other heating devices, thoroughly ventilate the room to avoid oxygen deficiency.
- In certain functional environments, such as kitchens, server rooms, etc., the use of specially designed air-conditioning units is highly recommended.
- Unplug the unit or disconnect the power supply to the unit if strange sounds, smell, or smoke comes from it.
- To further optimize the performance of your unit, keep doors and windows closed during operation.
- Pay attention when unpacking and installing. Sharp edges could cause injury.

CLEANING AND MAINTENANCE WARNINGS

- Turn off the device and disconnect the power before cleaning. Failure to do so can cause electrical shock.
- **Do not** clean the air conditioner with excessive amounts of water.
- **Do not** clean the air conditioner with combustible cleaning agents. Combustible cleaning agents can cause fire or deformation.



CAUTION

- Turn off the air conditioner and disconnect the power if you are not going to use it for a long time.
- Turn off and unplug the unit during storms.
- Make sure that water condensation can drain unhindered from the unit.
- **Do not** operate the air conditioner with wet hands. This may cause electric shock.
- **Do not** use device for any other purpose than its intended use.
- **Do not** climb onto or place objects on top of the outdoor unit.
- **Do not** allow the air conditioner to operate for long periods of time with doors or windows open, or if the humidity is very high.



ELECTRICAL WARNINGS

- Only use the specified power cord. If the power cord is damaged, it must be replaced by the manufacturer, its service agent or similarly qualified persons in order to avoid a hazard.
- Keep power plug clean. Remove any dust or grime that accumulates on or around the plug. Dirty plugs can cause fire or electric shock.
- **Do not** pull power cord to unplug unit. Hold the plug firmly and pull it from the outlet. Pulling directly on the cord can damage it, which can lead to fire or electric shock.
- **Do not** modify the length of the power supply cord or use an extension cord to power the unit.
- **Do not** share the electrical outlet with other appliances. Improper or insufficient power supply can cause fire or electrical shock. Always install circuit breaker and a dedicated power circuit.
- **Do not** use the socket if it is loose or damaged.
- **Do not** place heavy object on the power cord and ensure that the cord is not compressed. There is danger of fire or electric shock.
- If water enters the unit, turn the unit off at the power outlet and switch off the circuit breaker. Isolate supply by taking the power-plug out or disconnect the power supply to the unit, contact a qualified service technician.
- The product must be properly grounded at the time of installation, or electrical shock may occur.
- For all electrical work, follow all local and national wiring standards, regulations, and the Electrical Connection Diagram located on the top panel of the unit.
- If connecting power to fixed wiring, an all-pole disconnection device which has at least 3mm clearances in all poles, and have a leakage current that may exceed 10mA, the residual current device(RCD) having a rated residual operating current not exceeding 30mA, and disconnection must be incorporated in the fixed wiring in accordance with the wiring rules.
- This unit is earthed through the power cord, make sure that the unit is correctly grounded. The wall outlet(Air-break switch) should be provided with reliable earth wire.
- The unit should be provided with an individual circuit and the circuit breaker/fuse rating should be the same as that of the power cord and wall outlet. Power cord conductors are distinguished according to the color as shown in Wiring Diagram located on the top of the machine.

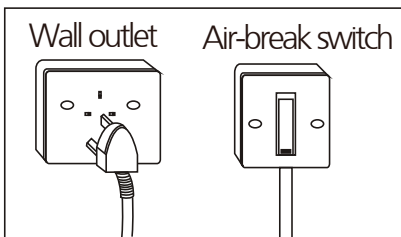

TAKE NOTE OF FUSE SPECIFICATIONS

The air conditioner's circuit board (PCB) is designed with a fuse to provide overcurrent protection. The specifications of the fuse are printed on the circuit board, such as 220V.



WARNINGS FOR PRODUCT INSTALLATION

1. Installation must be performed by an authorized dealer or specialist. Defective installation can cause water leakage, electrical shock, or fire.
2. Installation must be performed according to the installation instructions. Improper installation can cause water leakage, electrical shock, or fire.
3. Contact an authorized service technician for repair or maintenance of this unit. This appliance shall be installed in accordance with national wiring regulations.
4. Only use the included accessories, parts, and specified parts for installation. Using non-standard parts can cause water leakage, electrical shock, fire, and can cause the unit to fail.
5. Install the unit in a firm location that can support the unit's weight. If the chosen location cannot support the unit's weight, or the installation is not done properly, the unit may drop and cause serious injury and damage.
6. Install drainage piping according to the instructions in this manual. Improper drainage may cause water damage to your home and property.
7. For units that have an auxiliary electric heater, do not install the unit within 1 meter (3 feet) of any combustible materials.
8. **Do not** install the unit in a location that may be exposed to combustible gas leaks. If combustible gas accumulates around the unit, it may cause fire.
9. **Do not** turn on the power until all work has been completed.
10. When moving or relocating the air conditioner, consult experienced service technicians for disconnection and reinstallation of the unit.
11. How to install the appliance to its support, please read the information for details in "Installation instructions" section.



WARNING for Using R32 Refrigerant

- Do not** use means to accelerate the defrosting process or to clean, other than those recommended by the manufacturer.
- The appliance shall be stored in a room without continuously operating ignition sources (for example: open flames, an operating gas appliance) and ignition sources (for example: an operating electric heater) close to the appliance. The appliance shall be stored in a room without continuously operating ignition sources (for example: open flames, an operating gas appliance or an operating electric heater).
- Do not** pierce or burn.
- Be aware that the refrigerants may not contain an odour.
- Compliance with national gas regulations shall be observed.
- Keep ventilation openings clear of obstruction.
- The appliance shall be stored so as to prevent mechanical damage from occurring.
- A warning that the appliance shall be stored in a well-ventilated area where the room size corresponds to the room area as specified for operation.
- Any person who is involved with working on or breaking into a refrigerant circuit should hold a current valid certificate from an industry-accredited assessment authority, which authorises their competence to handle refrigerants safely in accordance with an industry recognised assessment specification.
- Servicing shall only be performed as recommended by the equipment manufacturer. Maintenance and repair requiring the assistance of other skilled personnel shall be carried out under the supervision of the person competent in the use of flammable refrigerants.
- Please follow the instruction carefully to handle, install, clear, service the air conditioner to avoid any damage or hazard. Mildly Flammable Refrigerant R32 is used within air conditioner. When maintaining or disposing the air conditioner, the refrigerant (R32) shall be recovered properly, shall not discharge to air directly.
- No any open fire or device like switch which may generate spark/arcing shall be around air conditioner to avoid causing ignition of the flammable refrigerant used. Please follow the instruction carefully to store or maintain the air conditioner to prevent mechanical damage from occurring.
- Mildly Flammable refrigerant is used in air conditioner. Please follow the instruction carefully to avoid any hazard.





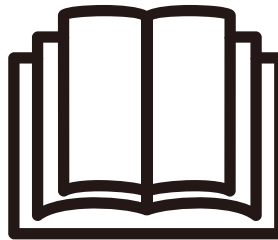

WARNING: low burning velocity material
(For R32 models apply to IEC60335-2-40:2018)



IMPORTANT NOTE: Read this manual carefully before installing or operating your new air conditioning unit.

Explanation of symbols displayed on the unit(For the unit adopts R32 Refrigerant only):

	WARNING	This symbol shows that this appliance used a mildly flammable refrigerant. If the refrigerant is leaked and exposed to an external ignition source, there is a risk of fire.		CAUTION	This symbol shows that a service personnel should be handling this equipment with reference to the installation manual.
	CAUTION	This symbol shows that the operation manual should be read carefully.		CAUTION	This symbol shows that information is available such as the operating manual or installation manual.

1.Transport of equipment containing flammable refrigerants

See transport regulations

2.Marking of equipment using signs

See local regulations

3.Disposal of equipment using flammable refrigerants

See national regulations.

4.Storage of equipment/appliances

The storage of equipment should be in accordance with the manufacturer's instructions.

5.Storage of packed (unsold) equipment

Storage package protection should be constructed such that mechanical damage to the equipment inside the package will not cause a leak of the refrigerant charge.The maximum number of pieces of equipment permitted to be stored together will be determined by local regulations.

6.Information on servicing

1)Checks to the area

Prior to beginning work on systems containing flammable refrigerants, safety checks are necessary to ensure that the risk of ignition is minimised. For repair to the refrigerating system, the following precautions shall be complied with prior to conducting work on the system.

2)Work procedure

Work shall be undertaken under a controlled procedure so as to minimise the risk of a flammable gas or vapour being present while the work is being performed.

3)General work area

All maintenance staff and others working in the local area shall be instructed on the nature of work being carried out. Work in confined spaces shall be avoided. The area around the workspace shall be sectioned off. Ensure that the conditions within the area have been made safe by control of flammable material.

4)Checking for presence of refrigerant

The area shall be checked with an appropriate refrigerant detector prior to and during work, to ensure the technician is aware of potentially flammable atmospheres. Ensure that the leak detection equipment being used is suitable for use with flammable refrigerants, i.e. non-sparking, adequately sealed or intrinsically safe.

5)Presence of fire extinguisher

If any hot work is to be conducted on the refrigeration equipment or any associated parts,appropriate fire extinguishing equipment shall be available to hand. Have a dry powder or CO₂ fire extinguisher adjacent to the charging area.

6)No ignition sources

No person carrying out work in relation to a refrigeration system which involves exposing any pipe work that contains or has contained flammable refrigerant shall use any sources of ignition in such a manner that it may lead to the risk of fire or explosion. All possible ignition sources, including cigarette smoking, should be kept sufficiently far away from the site of installation, repairing, removing and disposal, during which flammable refrigerant can possibly be released to the surrounding space. Prior to work taking place, the area around the equipment is to be surveyed to make sure that there are no flammable hazards or ignition risks. No Smoking signs shall be displayed.

7)Ventilated area

Ensure that the area is in the open or that it is adequately ventilated before breaking into the system or conducting any hot work. A degree of ventilation shall continue during the period that the work is carried out. The ventilation should safely disperse any released refrigerant and preferably expel it externally into the atmosphere.

8)Checks to the refrigeration equipment

Where electrical components are being changed, they shall be fit for the purpose and to the correct specification. At all times the manufacturer's maintenance and service guidelines shall be followed. If in doubt consult the manufacturer's technical department for assistance. The following checks shall be applied to installations using flammable refrigerants:

The charge size is in accordance with the room size within which the refrigerant containing parts are installed;

The ventilation machinery and outlets are operating adequately and are not obstructed;

If an indirect refrigerating circuit is being used, the secondary circuit shall be checked for the presence of refrigerant;

Marking to the equipment continues to be visible and legible. Markings and signs that are illegible shall be corrected; Refrigeration pipe or components are installed in a position where they are unlikely to be exposed to any substance which may corrode refrigerant containing components, unless the components are constructed of materials which are inherently resistant to being corroded or are suitably protected against being so corroded.

9) Checks to electrical devices

Repair and maintenance to electrical components shall include initial safety checks and component inspection procedures. If a fault exists that could compromise safety, then no electrical supply shall be connected to the circuit until it is satisfactorily dealt with. If the fault cannot be corrected immediately but it is necessary to continue operation, an adequate temporary solution shall be used. This shall be reported to the owner of the equipment so all parties are advised.

Initial safety checks shall include:

That capacitors are discharged: this shall be done in a safe manner to avoid possibility of sparking;

That there no live electrical components and wiring are exposed while charging, recovering or purging the system;

That there is continuity of earth bonding.

7. Repairs to sealed components

1) During repairs to sealed components, all electrical supplies shall be disconnected from the equipment being worked upon prior to any removal of sealed covers, etc. If it is absolutely necessary to have an electrical supply to equipment during servicing, then a permanently operating form of leak detection shall be located at the most critical point to warn of a potentially hazardous situation.

2) Particular attention shall be paid to the following to ensure that by working on electrical components, the casing is not altered in such a way that the level of protection is affected. This shall include damage to cables, excessive number of connections, terminals not made to original specification, damage to seals, incorrect fitting of glands, etc.

Ensure that apparatus is mounted securely.

Ensure that seals or sealing materials have not degraded such that they no longer serve the purpose of preventing the ingress of flammable atmospheres. Replacement parts shall be in accordance with the manufacturer's specifications.

NOTE: The use of silicon sealant may inhibit the effectiveness of some types of leak detection equipment. Intrinsically safe components do not have to be isolated prior to working on them.

8. Repair to intrinsically safe components

Do not apply any permanent inductive or capacitance loads to the circuit without ensuring that this will not exceed the permissible voltage and current permitted for the equipment in use. Intrinsically safe components are the only types that can be worked on while live in the presence of a flammable atmosphere. The test apparatus shall be at the correct rating. Replace components only with parts specified by the manufacturer. Other parts may result in the ignition of refrigerant in the atmosphere from a leak.

9. Cabling

Check that cabling will not be subject to wear, corrosion, excessive pressure, vibration, sharp edges or any other adverse environmental effects. The check shall also take into account the effects of aging or continual vibration from sources such as compressors or fans.

10. Detection of flammable refrigerants

Under no circumstances shall potential sources of ignition be used in the searching for or detection of refrigerant leaks. A halide torch (or any other detector using a naked flame) shall not be used.

11. Leak detection methods

The following leak detection methods are deemed acceptable for systems containing flammable refrigerants. Electronic leak detectors shall be used to detect flammable refrigerants, but the sensitivity may not be adequate, or may need recalibration. (Detection equipment shall be calibrated in a refrigerant-free area.) Ensure that the detector is not a potential source of ignition and is suitable for the refrigerant used. Leak detection equipment shall be set at a percentage of the LFL of the refrigerant and shall be calibrated to the refrigerant employed and the appropriate percentage of gas (25 % maximum) is confirmed. Leak detection fluids are suitable for use with most refrigerants but the use of detergents containing chlorine shall be avoided as the chlorine may react with the refrigerant and corrode the copper pipe-work. If a leak is suspected, all naked flames shall be removed/ extinguished. If a leakage of refrigerant is found which requires brazing, all of the refrigerant shall be recovered from the system, or isolated (by means of shut off valves) in a part of the system remote from the leak. Oxygen free nitrogen (OFN) shall then be purged through the system both before and during the brazing process.

12. Removal and evacuation

When breaking into the refrigerant circuit to make repairs or for any other purpose conventional procedures shall be used. However, it is important that best practice is followed since flammability is a consideration. Opening of the refrigeration systems shall not be done by brazing. The following procedure shall be adhered to:

Remove refrigerant;

Purge the circuit with inert gas;

Evacuate;

Purge again with inert gas;

Open the circuit by cutting or brazing.

The refrigerant charge shall be recovered into the correct recovery cylinders. The system shall be flushed with OFN to

render the unit safe. This process may need to be repeated several times. Compressed air or oxygen shall not be used for this task.

Flushing shall be achieved by breaking the vacuum in the system with OFN and continuing to fill until the working pressure is achieved, then venting to atmosphere, and finally pulling down to a vacuum. This process shall be repeated until no refrigerant is within the system.

When the final OFN charge is used, the system shall be vented down to atmospheric pressure to enable work to take place. This operation is absolutely vital if brazing operations on the pipe-work are to take place.

Ensure that the outlet for the vacuum pump is not close to any ignition sources and there is ventilation available.

13. Charging procedures

In addition to conventional charging procedures, the following requirements shall be followed. Ensure that contamination of different refrigerants does not occur when using charging equipment. Hoses or lines shall be as short as possible to minimise the amount of refrigerant contained in them.

Cylinders shall be kept upright.

Ensure that the refrigeration system is earthed prior to charging the system with refrigerant.

Label the system when charging is complete (if not already).

Extreme care shall be taken not to overfill the refrigeration system.

Prior to recharging the system it shall be pressure tested with OFN. The system shall be leak tested on completion of charging but prior to commissioning. A follow up leak test shall be carried out prior to leaving the site.

14. Decommissioning

Before carrying out this procedure, it is essential that the technician is completely familiar with the equipment and all its detail. It is recommended good practice that all refrigerants are recovered safely. Prior to the task being carried out, an oil and refrigerant sample shall be taken in case analysis is required prior to re-use of reclaimed refrigerant. It is essential that electrical power is available before the task is commenced.

- a) Become familiar with the equipment and its operation.
- b) Isolate system electrically.
- c) Before attempting the procedure ensure that:
 - Mechanical handling equipment is available, if required, for handling refrigerant cylinders;
 - All personal protective equipment is available and being used correctly;
 - The recovery process is supervised at all times by a competent person;
 - Recovery equipment and cylinders conform to the appropriate standards.
- d) Pump down refrigerant system, if possible.
- e) If a vacuum is not possible, make a manifold so that refrigerant can be removed from various parts of the system.
- f) Make sure that cylinder is situated on the scales before recovery takes place.
- g) Start the recovery machine and operate in accordance with manufacturer's instructions.
- h) **Do not** overfill cylinders. (No more than 80 % volume liquid charge).
- i) **Do not** exceed the maximum working pressure of the cylinder, even temporarily.
- j) When the cylinders have been filled correctly and the process completed, make sure that the cylinders and the equipment are removed from site promptly and all isolation valves on the equipment are closed off.
- k) Recovered refrigerant shall not be charged into another refrigeration system unless it has been cleaned and checked.

15. Labelling

Equipment shall be labelled stating that it has been de-commissioned and emptied of refrigerant. The label shall be dated and signed. Ensure that there are labels on the equipment stating the equipment contains flammable refrigerant.

16. Recovery

When removing refrigerant from a system, either for servicing or decommissioning, it is recommended good practice that all refrigerants are removed safely. When transferring refrigerant into cylinders, ensure that only appropriate refrigerant recovery cylinders are employed. Ensure that the correct number of cylinders for holding the total system charge is available. All cylinders to be used are designated for the recovered refrigerant and labelled for that refrigerant (i.e. special cylinders for the recovery of refrigerant). Cylinders shall be complete with pressure relief valve and associated shut-off valves in good working order. Empty recovery cylinders are evacuated and, if possible, cooled before recovery occurs.

The recovery equipment shall be in good working order with a set of instructions concerning the equipment that is at hand and shall be suitable for the recovery of flammable refrigerants. In addition, a set of calibrated weighing scales shall be available and in good working order. Hoses shall be complete with leak-free disconnect couplings and in good condition. Before using the recovery machine, check that it is in satisfactory working order, has been properly maintained and that any associated electrical components are sealed to prevent ignition in the event of a refrigerant release. Consult manufacturer if in doubt.

The recovered refrigerant shall be returned to the refrigerant supplier in the correct recovery cylinder, and the relevant Waste Transfer Note arranged. Do not mix refrigerants in recovery units and especially not in cylinders. If compressors or compressor oils are to be removed, ensure that they have been evacuated to an acceptable level to make certain that flammable refrigerant does not remain within the lubricant. The evacuation process shall be carried out prior to returning the compressor to the suppliers. Only electric heating to the compressor body shall be employed to accelerate this process. When oil is drained from a system, it shall be carried out safely.

When flammable refrigerant are employed, appliance shall be stored in a well -ventilated area.

Operating temperature

When your air conditioner is used outside of the following temperature ranges, certain safety protection features may activate and cause the unit to disable.

Cooling operation	Outdoor Temperature	18°C-43°C (64°F-109°F)
	Indoor Temperature	17°C-32°C (62°F-90°F)

To further optimize the performance of your unit, do the following:

- Keep doors and windows closed.
- The capacity of the air conditioner must fit the room size for efficient and satisfactory operation.
- **Do not** block air inlets or outlets.
- Regularly inspect and clean air filters.
- If the power supplied to the unit is not plus/minus 10% of the specified rating, the unit may not function and the fuse may blow.
- Noise from the air conditioner will be louder at night than in the daytime. This is because the noise in the surroundings is comparatively low at night. If your feel that the noise is too loud, switch the thermostat to lower numbers.

UNIT PARTS IDENTIFICATION

NOTE: Different models have different front panels and cabinets. Illustrations in this manual are for explanatory purposes. The actual shape of your indoor unit may be slightly different. The actual shape shall prevail. See the following figures for references:

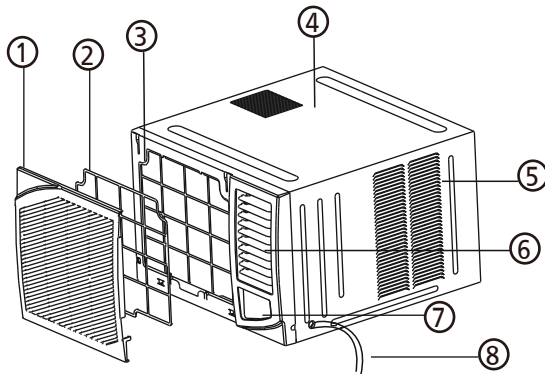

1. Front panel
2. Air filter
3. Frame
4. Cabinet
5. Air inlet grille (outdoor side)
6. Air outlet grille
7. Knob control
8. Power supply cord

Accessories

Seal (Used on drain joint)	Drain Joint	Drain pan	Rubber Plug	Screw
1 pc	1 pc	1 pc	1 pc	2 pcs

Vent Control

The vent control is located above the control knobs. The operation method and the shape may vary in different models (see the following figures)

For maximum cooling efficiency, CLOSE the vent. It will allow internal air circulation. OPEN the vent to discharge stale air.

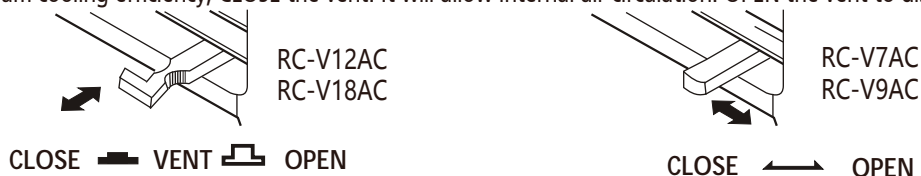

NOTE: The vent control is not available for all the units. Some units do not have vent control.

Operation panel

	1-12	

How to operate

THERMOSTAT

THERMOSTAT

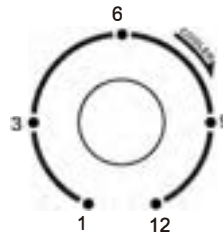

SELECTOR

SELECTOR

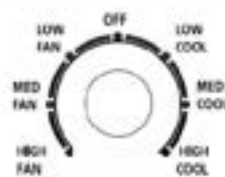

RC-V7AC
RC-V9AC
RC-V12AC



RC-V18AC

CAUTION:

If the SELECTOR is turned off or set to fan mode from cooling mode, wait for at least 3 minutes before resetting to cooling mode. When turning the SELECTOR from LOW COOL to HIGH COOL, keep your speed slow and remember not to change the operation mode too often.

For example:

To obtain maximum cooling effect in hot summer, select position HIGH COOL on the SELECTOR. When the SELECTOR is set at "HIGH FAN" position, the fan only is actuated so that the air is circulated without cooling effect.

IMPORTANT: If the SELECTOR is turned off or set to fan mode from cooling mode, wait for at least 3 minutes before resetting to cooling mode. When turning the SELECTOR from LOW COOL to HIGH COOL, keep your speed slow and remember not to change the operation mode too often.

Operation panel cover

For the units with operation panel cover

1. Grasp the top or the left of the operation cover and pull it to open it.
2. Close the operation cover and press the cover again until it snaps into the locked position.

DO NOT press or swing the opened operation cover.

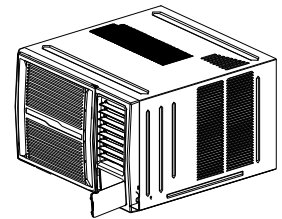

Air direction control

• **Horizontal airflow adjustment**

For the units with AUTO SWING switch (Automatically)

When the AUTO SWING switch is turned to "ON" position, the horizontal airflow louvers oscillate right and left sweeping the cold air alternately to obtain comfortable cooling. The louvers may be stopped at any position when the AUTO SWING switch is turned to "OFF" position (see Fig. A).

• **For the units with manual control lever (Manually)**

To adjust horizontal airflow direction, move the lever gently to the left or right by hand until the desired horizontal airflow direction is obtained (see Fig. B).

Vertical airflow adjustment (Manually)

When the unit is operating, use the hand to adjust the louvers to change the vertical airflow direction. The vertical angle of air flow can be set by gripping the louver and move to the desired position (see Fig. C).

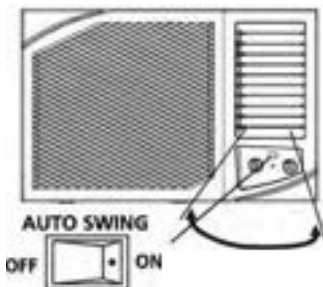

Fig. A

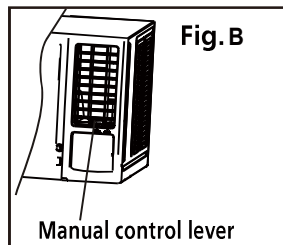

Fig. B

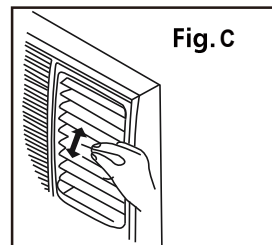

Fig. C

CARE AND MAINTENANCE



BEFORE CLEANING OR MAINTENANCE

ALWAYS TURN OFF YOUR AIR CONDITIONER SYSTEM AND DISCONNECT ITS POWER SUPPLY BEFORE CLEANING OR MAINTENANCE.

Cleaning Your Unit



IMPORTANT

The cabinet and front panel may be dusted with an oil-free cloth or washed with a cloth dampened in a solution of warm water and mild liquid dishwashing detergent. Rinse thoroughly and wipe dry.

- **Do not** use inflammable sprays such as lacquer or hair spray near the air conditioner
- **Do not** use benzene, alcohol, gasoline, acid, paint thinner, polishing powder or other solvents to clean the unit. The unit can be damaged.
- **Do not** use water hotter than 50°C (122°F) to clean the front panel. This can cause the panel to deform or become discolored.
- Excess water in or around the controls may cause damage to the air conditioner. Be sure to wring excess water from the cloth before wipe it clean.

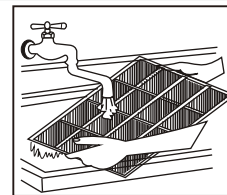
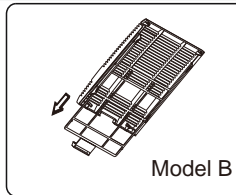
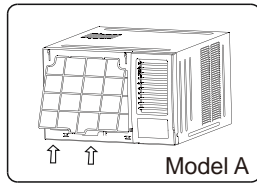
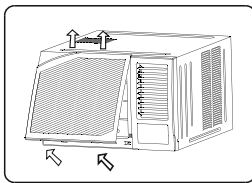

Cleaning Your Air Filter

A clogged air filter can reduce the cooling efficiency of your unit and increase operating noise. Make sure to clean the filter once every two weeks (or as necessary) during periods of frequent operation.

1. Hold the slot under the front panel, then uplift it outwards, and remove the front panel.
2. Pinch the handle under the air filter and make the air filter arched, remove it from the slot from underside to upside (Model A). Grasp the handle of the filter, then slide it downwards to remove the filter (Model B).
3. Clean the filter with warm, soapy water. The water should be below 40°C (104°F) to prevent distortion of the filter.
4. If your filter has a small air freshening filter, clean this air freshening filter with a hand-held vacuum.
5. Rinse the air filter with fresh water, then shake off excess water.
6. Dry it in a cool, dry place, and refrain from exposing it to direct sunlight.

If your filter has a small air freshening filter (optional), it can be installed at any of the four positions, install it at the position as you like. Clean it with a hand-held vacuum.

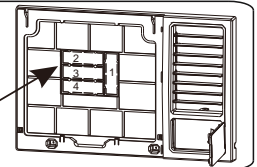

CAUTION

NEVER operate the air conditioner without the air filter, as dust/dirt particles can contribute to equipment failure.

Winter Storage

If you plan to store the air conditioner during the winter, remove it carefully from the window according to the installation instructions. Cover it with plastic or return it to the original carton.

WATER DRAINAGE

The condensed water can be treated as follows:

Bottom drainage (Applicable for the units designed with bottom drain hole only.)

- Remove the rubber plug from the bottom of cabinet (if any)
- Take out the drain pan and screws from accessory.
- Fix the drain pan onto the bottom of cabinet by screws.
- Connect an extension drain hose (locally purchased) to the outlet of drain tray.

NOTE: The bottom drainage will slightly affect cooling performance, but it can reduce the noise caused by spraying the condensed water. For pump heating, the bottom drainage must be chosen.

Back drainage

- Fit the seal onto the drain joint (provided as accessory).
- Insert the drain joint to the back drainage hole, and rotate it by 90° to be well fitted.
- Connect an extension drain hose (locally purchased according to the installation length request) to the drain joint.
- Make sure to plug the bottom drain hole by rubber plug.

NOTE: The back drainage will slightly affect cooling performance, but will reduce the noise caused by spraying the condensed water.

Non-drainage

If you choose non-drainage when cooling, both the bottom and the back drain holes of the unit should be plugged with rubber plugs. The condensed water will be sprayed to condenser, and will improve the cooling performance.

NOTE: When you choose non-drainage, the air conditioner will be perfect cooling efficiency, but big noise may be caused by spraying the condensed water. Please do not choose it if you are sensitive to the noise.

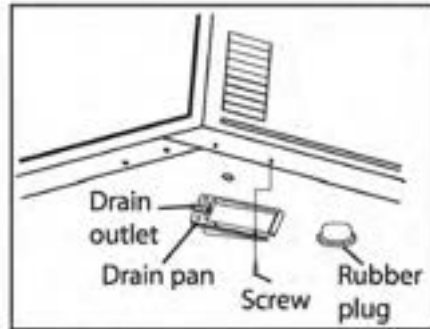
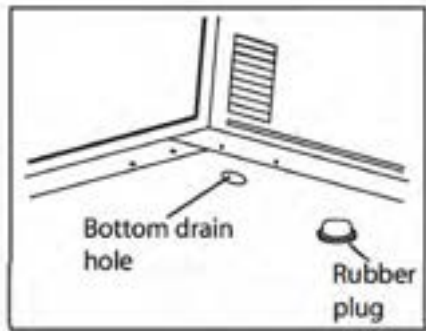

Bottom drainage

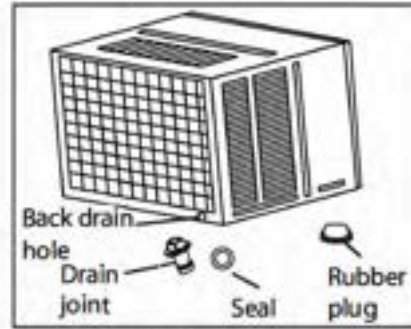

Back drainage

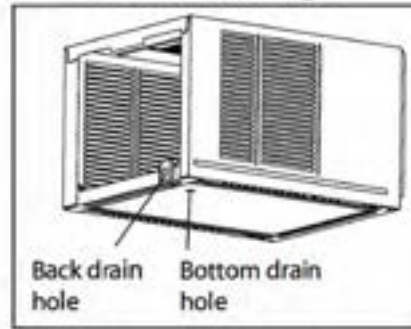

Non-drainage

Note on the product

- The rated cooling performance is tested under non-drainage status.
- Make sure that water will not leak from the surrounding area when rubber plug and joint were used. Please seal it in case leakage is found.

INSTALLATION INSTRUCTIONS

Prior to installation

CAUTION: Before installing, remove all packaging from inside the carton.

Step 1: Select the best location

1. To avoid vibration and noise, make sure the unit is installed securely and firmly.
2. Install the unit where the sunlight does not shine directly on the unit. If the unit receives direct sunlight, build an awning to shade the cabinet.
3. There should be no obstacle, such as a fence or wall, within 50cm from the back of the cabinet because it will prevent heat radiation of the condenser. Restriction of outside air will greatly reduce the cooling and heating efficiency of the air conditioner.
4. Install the unit a little obliquely downward to outside not to leak the condensed water into the room (about 3~4°).
5. Install the unit with its bottom portion 75~150cm above the floor level.
6. The power cord must be connected to an independent circuit. The yellow/green wire must be grounded.

CAUTION

All side louvers of the cabinet must remain exposed to the outside of the structure.

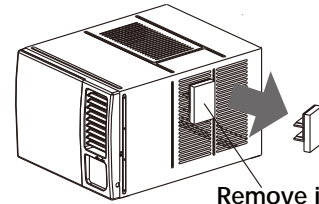

Remove inserts placed into the side louvers

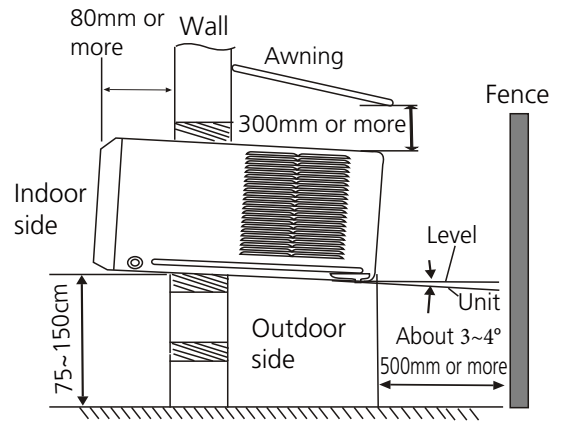

Option A

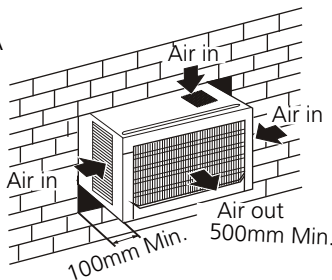

Option B

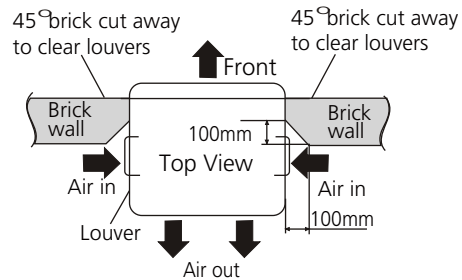

Step 2: Remove the front panel and air filter

1. Take out the air conditioner from its packaging.
2. Hold the slot under the front panel, then uplift it outwards, and remove the front panel (See Fig. 1)
3. Grip the tab at the end of the filter, lift it up, then pull it towards yourself, pull the filter out (see Fig. 2)

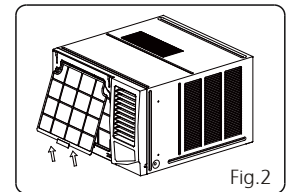
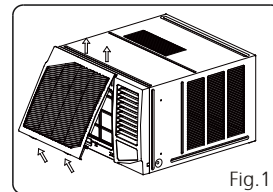

Step 3: Remove the frame

1. Remove two screws at the bottom of the frame. (See Fig. 3)
2. Disconnect the coupler plugs and make sure not to interfere with the temperature sensor cable. Hold the left bottom side of the frame, lift it up to unlatch the lower side, remove it toward you (See Fig. 4)

NOTE: For some units the front panel and frame do not install on the machine placed at the back of the unit, step 2 and step 3 do not need.

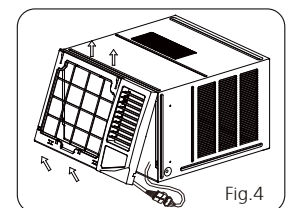
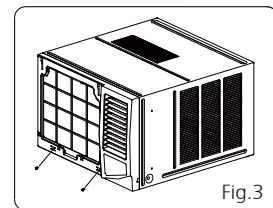

Step 4: Remove the cabinet

NOTE: There are slight differences on removing the cabinet according to the different models.

1. Remove one screw securing the chassis fixing bracket, then take down the chassis fixing bracket. Remove two screws located on the back of the cabinet as shown in Fig. 5B.
2. Grasp the handle on the chassis and carefully slide the air conditioner out of the cabinet. (see Fig. 6)

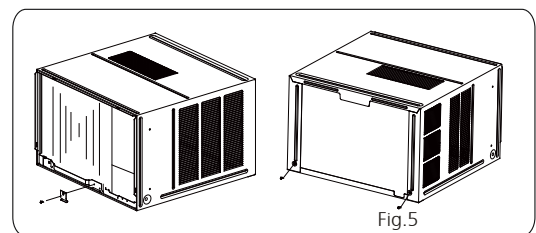

Step 5: Install the cabinet

NOTE: Unit may be supported by a solid frame from below or by a hanger from a solid overhead support(not supplied, purchase separately, please contact the dealer).

1. When need to drain off water, install the drain plug on the chassis board.
2. Prepare the hole in the wall so that the bottom of the cabinet is well supported, the top has minimum clearance and the air inlet louvers have clearance as shown in previous page(Fig. Option A & B). Holes from the outside through to the cavity should be sealed. The cabinet should slop down towards the rear by about 5~7mm to allow water formed during operation to drain.
3. Install the cabinet into the wall and secure. Ensure the foam seals are not damaged. Flash, seal or fill gaps around the inside and outside to provide satisfactory appearance and protection against the weather, insects and rodents. (see Fig.7)

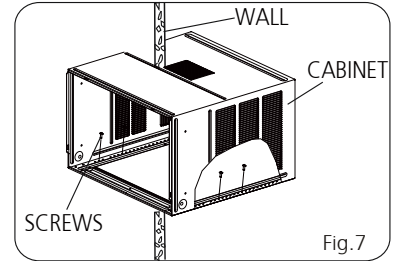
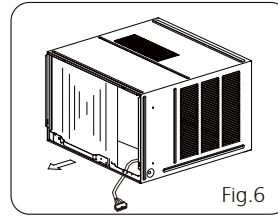

Step 6: Install the unit into the cabinet

1. Slide the unit into the cabinet until it is firmly against the rear of the cabinet. Care is required to ensure the foam sealing strips on the cabinet remain in position (See Fig.8).
2. Connect the air conditioner to the power and position excess cord length beneath the air conditioner base.
3. Engage the chassis fixing brackets into the bottom cabinet rail and secure to the base with the screw provided.

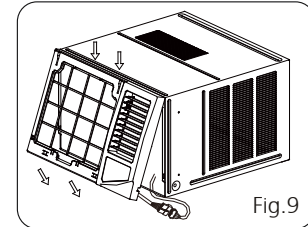
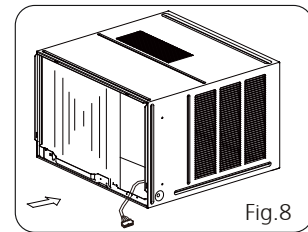
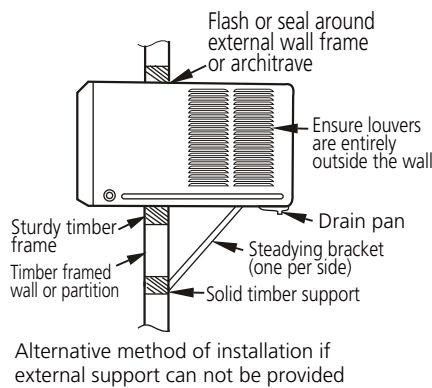
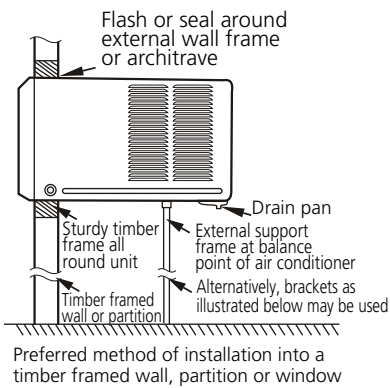

Step 7: Install the frame

1. Hook the upper edge of the frame. Then connect the coupler plugs and make sure not to interfere with the temperature sensor cable(see Fig.9).
2. Press the both side and lower edge of the frame, and secure it with the two screws at the bottom of the frame.(See Fig. 10)

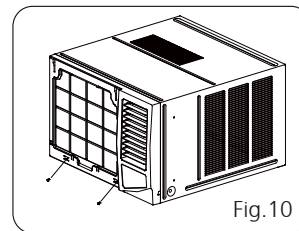

Step 8: Install the air filter and front panel

1. Insert the air filter into the frame's slot from upside to underside. (See Fig. 2)
2. Hang the front panel on the frame's buckle, then press the front panel into the frame's slot until you hear a click (see Fig.11).
3. Switch unit on. Check for operation of the unit and check for vibration after installation.
4. Fit the drain pan to the cabinet and run a drain hose to a suitable location if required.

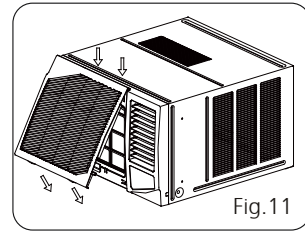

NOTE: For the unit with power cord comes out from left side, please perform the following steps:

1. Pull the power cord to the left side straightly(See Fig.a & b).
2. Wrap the PVC protecting sheath on the power cord with cable ties in the hole position (see Fig.c).
3. Tie up the power cord on the frame (see Fig.d & e) (Applicable for units with body dimension of 600mm*380mm*560mm only)
4. Install the frame and front panel according to the above Step 6 and Step 7.

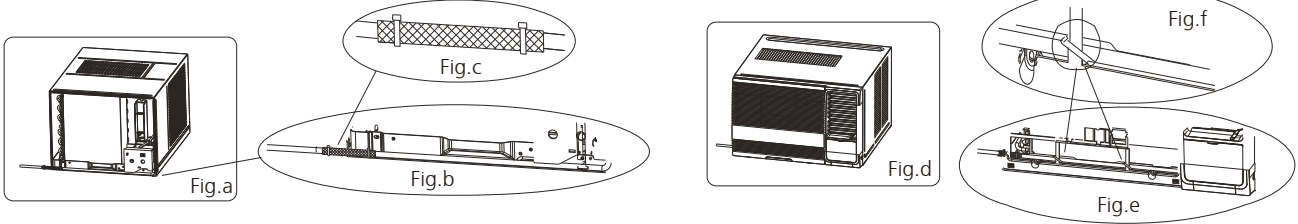

Troubleshooting



SAFETY PRECAUTIONS

If ANY of the following conditions occurs, turn off your unit immediately!

- The power cord is damaged or abnormally warm
- You smell a burning odor
- The unit emits loud or abnormal sounds
- A power fuse blows or the circuit breaker frequently trips
- Water or other objects fall into or out of the unit

DO NOT ATTEMPT TO FIX THESE YOURSELF! CONTACT SHUN HING ELECTRIC SERVICECENTRE LTD. !

Common Issues

The following problems are not a malfunction and in most situations will not require repairs.

Problem	Possible Causes	What To Do
Air conditioner does not start	<ul style="list-style-type: none"> • The air conditioner is unplugged. 	<ul style="list-style-type: none"> • Make sure the air conditioner plug is pushed completely into the outlet and switched on.
	<ul style="list-style-type: none"> • The fuse is blown/ circuit breaker is tripped. 	<ul style="list-style-type: none"> • Check the house fuse/circuit breaker box and replace the fuse or reset the breaker.
	<ul style="list-style-type: none"> • Power failure. 	<ul style="list-style-type: none"> • If power failure occurs, switch off and disconnect /unplug the power cord. When power is restored, reconnect (plug in) the power cord, switch on the power and wait 3 minutes to restart the air conditioner to prevent tripping of the compressor overload.
Air conditioner does not cool enough	<ul style="list-style-type: none"> • Airflow is restricted. 	<ul style="list-style-type: none"> • Make sure there are no curtains, blinds, or furniture blocking the front of the air conditioner.
	<ul style="list-style-type: none"> • The air filter is dirty. 	<ul style="list-style-type: none"> • Clean the filter at least every 2 weeks. • See the operating instructions section.
	<ul style="list-style-type: none"> • The room may have been hot. 	<ul style="list-style-type: none"> • When the air conditioner is first turned on you need to allow time for the room to cool down.
	<ul style="list-style-type: none"> • Cold air is escaping. 	<ul style="list-style-type: none"> • Check if doors and windows are opened. • Set the air conditioner's vent to the closed position.
	<ul style="list-style-type: none"> • Cooling coils have iced up. 	<ul style="list-style-type: none"> • See Air Conditioner Freezing Up below.
Air conditioner freezing up	<ul style="list-style-type: none"> • Ice blocks the air flow and stops the air conditioner from cooling the room. 	<ul style="list-style-type: none"> • Set the fan at MED or HIGH until the ice melts.
Noise when unit is cooling	<ul style="list-style-type: none"> • Air movement sound. 	<ul style="list-style-type: none"> • This is normal. If too loud, turn selector to lower FAN setting.
	<ul style="list-style-type: none"> • Sound of fan hitting water-moisture removal system. 	<ul style="list-style-type: none"> • This is normal when humidity is high. Close doors, windows and registers.
	<ul style="list-style-type: none"> • Window vibration - poor installation. 	<ul style="list-style-type: none"> • Refer to installation instructions or check with installer.

SPECIFICATIONS

Unit dimensions:

MODEL(But/h)	BODY DIMENSION(WxHxD)(mm)
RC-V7AC RC-V9AC	450.6x350x675
RC-V12AC	600x380x560
RC-V18AC	660x428x680

Note: For the different customization requirements, the depth of the panel may be slightly different. So the dimension of "D" is for reference only.

Choose the right cable size

The size of the power supply cable, signal cable, fuse, and switch needed is determined by the maximum current of the unit. The maximum current is indicated on the nameplate located on the side panel of the unit. Refer to this nameplate to choose the right cable, fuse, or switch.

The design and specifications are subject to change without prior notice for product improvement. Consult with the sales agency or manufacturer for details. Any updates to the manual will be uploaded to the service website, please check for the latest version.

● Special Avowal

- 1. The information above has been checked; our company reserves the hermeneutic power to any print errors or misunderstanding on the content.**
- 2. Any technology improvement will add into new instruction without any prior notices. The product appearance and color refer to the practical air conditioner.**
- 3. The e-copy of user manual can be sent by e-mail on requested, please call Shun Hing Electric Works & Engineering Co. Ltd. hotline at 2861 2767.**

● After sale service

Guarantee period state from the date of purchasing to one year. If the product is damaged under proper use, a free repair service is available. Please present the official invoice and the guarantee certificate with the sales point's chop / redemption center's chop for free maintenance. For enquiries, please contact Shun Hing Electric Service Centre Limited hotline at 2406 5666.

Turn off the power and contact Shun Hing Electric Service Centre Ltd. as soon as any of the following events occur.

- The circuit breaker frequently trips or the fuse blows regularly.
- If water or foreign objects have accidentally entered the air conditioner.
- If there is abnormal sound during operation.

信興電工工程有限公司

SHUN HING ELECTRIC WORKS & ENGINEERING CO., LTD

辦公室: 香港九龍尖沙咀東部麼地道 67 號半島中心 9 樓

OFFICE: 9/F, PENINSULA CENTRE, 67 MODY ROAD, TSIMSHATSUI EAST,
KOWLOON, HONG KONG

電話 TEL: (852) 2861 2767

傳真 FAX: (852) 2865 6706

網址 WEBSITE: www.rasonic.hk

電郵 EMAIL: shew@shunhinggroup.com

保養及維修 MAINTENANCE AND REPAIR SERVICE

信興電器服務中心有限公司

SHUN HING ELECTRIC SERVICE CENTRE LTD.

辦公室: 香港新界葵涌勝耀街2號信興中心11樓

OFFICE: 11TH FLOOR, SHUN HING CENTRE, 2 SHING YIU STREET, KWAI CHUNG, NEW
TERRITORIES, HONG KONG

電話 TEL: (852) 2406 5666

傳真 FAX: (852) 2408 0316

網址 WEBSITE: www.shesc.com

消耗品/附件銷售熱線 CONSUMABLES/ ACCESSORIES SALES HOTLINE

電話 TEL: (852) 2406 5666

客戶服務中心 CUSTOMER SERVICE CENTRES

香港新界葵涌勝耀街2號信興中心1樓

1ST FLOOR, SHUN HING CENTRE, 2 SHING YIU STREET, KWAI CHUNG, NEW
TERRITORIES, HONG KONG

電話 TEL: (852) 2406 5439

傳真 FAX: (852) 2408 1389

澳門慕拉士大馬路193-199號南嶺工業大廈5樓I座

AVENIDA DE VENCESLAU DE MORAIS, NO. 193-199, 5 ANDAR-I, EDF. INDUSTRIAL
NAM LENG, MACAU

電話 TEL: (853) 2836 2928

傳真 FAX: (853) 2833 6405

有關最新之客戶服務中心資訊, 請參閱信興服務中心網址: www.shesc.com或致電維修服務熱線查詢。

For the latest information of customer service centres, please visit www.shesc.com or call us at our hotline.